



# County of Santa Cruz

## Department of Public Works

701 Ocean Street, Room 410, Santa Cruz, CA 95060-4070  
 Phone: (831) 454-2160 Fax: (831) 454-2385 TDD: (831) 454-2123  
 John J. Presleigh, Director of Public Works

**Meeting Date:** August 8, 2017  
**Date:** July 20, 2017  
**To:** The Board of Supervisors  
**From:** John Presleigh, Director  
**Subject:** Approval of RFQ for the Santa Cruz County Library Renovation Project

On January 24, 2017, your Board approved a Work Plan for the Measure S County Library Projects. The Work Plan allows for significant upgrades to the La Selva Beach, Boulder Creek and the Live Oak library branches through the use of Measures S funding. This also creates an opportunity to achieve design development and cost efficiencies by selecting one architectural engineering team to complete design for the three branches. In order to move forward with the consultant selection process, it is requested that your Board approve the attached Request for Qualifications (RFQ) for the Santa Cruz County Library Renovation Project.

The RFQ describes proposed improvements at all three branches including: circulation and reference desk changes; accessibility improvements; lighting, power and data upgrades; and indoor and outdoor library programming areas enhancements to improve customer comfort and use, as well as library function. In addition to these improvements mechanical system upgrades are planned at the La Selva Beach Branch. The consultant's work will include preliminary design, preparation of construction and bidding documents, developing cost estimates and providing construction administration services. Community meetings will be scheduled during the preliminary design phase of work at each branch and the consultant will identify opportunities for donor funded enhancements.

Two additional improvements are proposed to be addressed independently of this RFQ. They include evaluation and upgrades to the existing septic system at the Boulder Creek Library, and evaluation and upgrades of the mechanical system at the Live Oak Library.

A selection committee including County and Santa Cruz Public Libraries staff will evaluate and rank the consultant proposals using the selection criteria in the RFQ. Public Works will return to your Board for authorization to award the contract on or before November 14, 2017. Sufficient funds are available in the current FY 2017-18

Plant Budget (GL Keys 191402, 191404, and 191405).

It is, therefore, RECOMMENDED that your Board:

1. Approve the Request for Qualifications for Architectural Engineering Services for the Santa Cruz County Library Renovation Project for the La Selva Beach, Boulder Creek and Live Oak Branches;
2. Authorize Public Works to begin distribution of the Request for Qualifications;
3. Direct the Clerk of the Board to advertise a Notice of Request for Qualifications on August 14, 2017, and August 21, 2017; and
4. Direct Public Works to return no later than November 14, 2017, with a recommendation for award of a contract.

**Submitted by:**

  
John Fresleigh, District Engineer 7/28/2017

**Recommended:**

Carlos J. Palacios, County Administrative Officer

**Attachments:**

- a RFQ Advertisement
- b 2017-SCCDPW Library Renovation RFQ

COUNTY OF SANTA CRUZ  
DEPARTMENT OF PUBLIC WORKS  
REQUEST FOR QUALIFICATION  
FOR ARCHITECTURAL ENGINEERING SERVICES FOR  
THE SANTA CRUZ COUNTY LIBRARY RENOVATION PROJECT FOR LA SELVA BEACH,  
BOULDER CREEK AND LIVE OAK BRANCHES

The County of Santa Cruz Department of Public Works is currently requesting submittal of qualifications for architectural engineering services for library interior and renovation work at the La Selva Beach, Boulder Creek and Live Oak Branch Libraries.

To be considered, the applicant must submit a response as detailed in the RFQ by **5:00 P.M., Wednesday, August 30, 2017**, to Betsey Lynberg, Director of Capital Projects, Department of Public Works, 701 Ocean Street, Room 410, Santa Cruz, CA 95060.

The Request for Qualifications is available for viewing and download on the Santa Cruz County's website at [www.ebidboard.com](http://www.ebidboard.com). Please call (831)454-2160 for more information.

# COUNTY OF SANTA CRUZ, CALIFORNIA

Request for Statement of Qualifications (RFQ)

FOR

*Santa Cruz County Library Renovation Project  
for the  
La Selva Beach, Boulder Creek and Live Oak Branches*

**RFQ DUE:  
Wednesday, August 30, 2017  
5:00 p.m. PDT**

In the Department of Public Works  
701 Ocean Street, Room 410  
Fourth Floor  
Santa Cruz, CA 95060

ATTN: Betsey Lynberg  
831/454-2393  
Betsey.Lynberg@santacruzcounty.us

Invitation Date:	August 9, 2017
Questions Deadline:	5:00 PM, August 22, 2017
Last Addendum:	5:00 PM, August 25, 2017
Submission Due Date:	5:00 PM, August 30, 2017

This notice is to inform you that Santa Cruz County Department of Public Works is soliciting a Request for Qualifications (RFQ) from qualified consulting professionals (Consultant) to provide architectural engineering consulting services for the Santa Cruz County Library Renovation Project for the La Selva Beach, Boulder Creek and Live Oak Branches.

Consultant selection will be based on qualifications and quality of the response submitted.

If you should have any questions regarding this Request for Qualifications, please contact Betsey Lynberg, Director of Capital Projects via email at [Betsey.Lynberg@santacruzcounty.us](mailto:Betsey.Lynberg@santacruzcounty.us). All questions regarding this RFQ must be submitted in writing either by fax or email.

Sincerely,

Betsey Lynberg  
Director of Capital Projects  
County of Santa Cruz  
Department of Public Works

**TABLE OF CONTENTS**

Introduction ..... 5

Tentative RFQ Schedule ..... 5

Scope of Work..... 6

Scope of Services ..... 7

Project Schedule ..... 11

Evaluation Criteria ..... 11

Submittal Requirements ..... 11

Standard Terms and Conditions..... 14

Selection Procedure ..... 15

Submittal Instructions ..... 16

Attachment: 2017-SCC DPW Library Renovation RFQ (Approval of RFQ for the Santa Cruz County Library Renovation Project)

## ATTACHMENTS

- 1. Tentative Project Schedule .....A1
- 2. La Selva Beach Branch Plans & Photos .....A2
- 3. Boulder Creek Branch Plans & Photos .....A3
- 4. Live Oak Branch Plans & Photos .....A4
- 5. Sample Independent Contractor Agreement (Design Professionals).....A5
- 6. Department of Public Works Protest and Appeals Procedures .....A6
- 7. Reservations.....A7

## **INTRODUCTION**

The Santa Cruz County Department of Public Works (SCCDPW) is soliciting a Request for Qualifications (RFQ) from qualified consulting professionals (Consultant) to provide architectural engineering consulting services for the Santa Cruz County Library Renovation Project for the La Selva Beach, Boulder Creek and Live Oak Branches. The purpose of this Request for Qualifications is to select a qualified architectural engineering team, led by an architect, to assess existing conditions, plan and design renovations, and perform construction administration services for primarily interior improvements at three branch libraries: La Selva Beach, Boulder Creek and Live Oak. These branches are owned and leased by the County of Santa Cruz and operated by the Santa Cruz Public Libraries. The size and character of each branch is different and it is the goal of the Santa Cruz Public Libraries that each branch reflect the character and needs of the community it serves while also incorporating system wide standards as appropriate. The contract for this work will be with the County of Santa Cruz Department of Public Works.

All work will be performed in accordance with County, Santa Cruz Public Libraries and other local and state practices, regulations, policies, procedures, manuals, and standards, as appropriate.

## **TENTATIVE RFQ SCHEDULE**

The following represents the tentative schedule for this RFQ. Any change in the scheduled dates for the Questions Deadline, or Submission Due Date will be advertised in the form of an addendum to this RFQ. The schedule for the evaluation process and other future dates may be adjusted without notice.

<b>Questions Deadline:</b>	<b>5:00 PM, August 22, 2017</b>
<b>Last Addendum:</b>	<b>5:00 PM, August 25, 2017</b>
<b>Submission Due Date:</b>	<b>5:00 PM, August 30, 2017</b>
<b>Evaluation of Responses:</b>	<b>August 31 – September 29, 2017</b>
<b>Interviews, if necessary:</b>	<b>October 5 or 6, 2017</b>
<b>Notify Consultants of Results:</b>	<b>October 6, 2017</b>
<b>Contract Negotiations:</b>	<b>October 10 – October 20, 2017</b>
<b>Board Approval of Contract:</b>	<b>November 14, 2017</b>



## SCOPE OF WORK

The SCCDPW is seeking consultants that have strong consulting skills, with particular emphasis on library interiors and renovation improvements. All work shall be supervised by an Architect licensed in the State of California, and other consultants shall be licensed in the State of California, as required to perform the requested services.

The Consultant and any sub-consultants shall be able to provide architectural, interior design, lighting, mechanical, plumbing and electrical engineering, and third party cost estimating services. Scope of Work by Branch:

### La Selva Beach Branch Library.

La Selva Beach Branch Library is a 2,200 square foot facility that was remodeled in 1995, and serves the La Selva Beach community an unincorporated residential area in southern Santa Cruz County. The branch is well used and operated in space leased from the La Selva Beach Recreation District. Adult and children collections and programming areas are provided. The initial construction budget for this branch is approximately \$300,000, not including furniture, fixtures and equipment. The work at this branch includes, but is not limited to:

- Renovation of the restroom and facilities for compliance with accessibility requirements
- HVAC system upgrades for comfort and performance
- Electrical upgrade as needed for building systems and improved power and data access for customers
- Replacement of service desk with a smaller desk
- New interior finishes
- Selection of new furniture, marketplace shelving and other new shelving as necessary
- Lighting, as necessary
- Upgrades to the patio for improved customer comfort and programming

### Boulder Creek Branch Library.

Boulder Creek Branch Library is a 4,600 square foot facility that serves the San Lorenzo Valley community in the unincorporated area of north Santa Cruz County. Adult and children collections and programming are provided. There is a separate children's area and a meeting/program room. A deck and outdoor amphitheater provide additional customer and programming space. The branch is operated in a building built in 1985 and owned by the County of Santa Cruz. The initial construction budget for this branch is approximately \$200,000, not including furniture, fixtures and equipment. The work at this branch includes, but is not limited to:

- Renovation of the restroom and facilities, including amphitheater handrails for compliance with accessibility requirements
- Electrical upgrades as needed for building systems and improved power and data access for customers
- Replacement of service desk with a smaller desk and reconfiguration of staff space to recapture space for the public
- Removal of the wood burning stove and replacement with an alternative fuel (e.g. gas) fireplace
- Shade canopy or other options to shade the outdoor amphitheater
- Replacement of tile flooring and other interior finishes as budget permits
- Selection of new “marketplace” shelving and other new shelving as necessary
- Improve acoustics in meeting room
- Lighting as necessary
- Work to be performed by others includes evaluation and upgrades to the on-site septic system

#### Live Oak Branch Library.

Live Oak Branch Library is a 13,500 square foot facility that serves an urbanized mid-county area known as Live Oak. The branch was opened in early 2006 and is operated in a building owned by the County of Santa Cruz. The branch includes an adult reading room, a young adult room, a story time area, and a homework center. The initial construction budget for this branch is approximately \$300,000, not including furniture, fixtures and equipment. The work for this branch includes, but is not limited to:

- Removal of adult and children’s reference desks and replacement with marketplace and other shelving and new flooring as necessary
- New or improved site signage to improve visibility
- Miscellaneous interior and exterior repairs
- Selection of new children’s area furniture, new “marketplace” shelving and other new shelving as necessary
- Analysis and recommendations for improved use of the second floor currently used as staff work space
- Work to be performed by others includes evaluation and upgrades to the HVAC system to improve operations and performance.

## SCOPE OF SERVICES

The scope of services outlined herein is presented as a preliminary scope of services to generally communicate the expectations for the provision of architectural and engineering services to be provided by the selected firm. A final scope of services will be negotiated with the selected consultant. The scope of services may consist of the following items for each branch, but are not limited to the following:

1. INVESTIGATION INTO EXISTING CONDITIONS: Review existing documentation and existing conditions to ascertain inadequately documented and/or hidden conditions, as well as conditions which do not comply with requirements of the American with Disabilities Act, and that will impact the development of the project.
2. SCHEMATIC/PRELIMINARY DESIGN PHASE:
  - a. The schematic/preliminary design documents shall convey initial indication of the design of the project, functional relationships of interior areas, accessibility of the interior areas and accessible path of travel, the materials to be used, the types of mechanical and electrical systems to be utilized. The architect shall prepare alternative concept sketches as necessary in order to convey design choices and shall coordinate with SCPL and SCCDPW to set priorities for the scope of work.
  - b. The architect shall prepare sketches, exhibits, images, and material boards as necessary, and a PowerPoint presentation suitable for a community meeting presentation to convey and receive community input on the schematic/preliminary design.
  - c. The architect shall identify opportunities and define features for project enhancements which may be suitable for donor funding and provide associated costs. The architect shall prepare a final donor package to include descriptions, sketches or illustrations, with cost for use by SCPL and Friends of the Santa Cruz Public Libraries.
  - d. The architect shall prepare a budget for upgrades and FFE, and have an independent cost estimator prepare a cost estimate for construction work.
  - e. Meetings during this phase shall include a project kick off meeting, a mid-point review meeting, an evening community meeting, and a phase completion meeting.
3. PUBLIC AGENCY COORDINATION:

- a. Coordinate with the Project Manager and agencies having jurisdiction as needed. Secure Construction Document plan check or County building permits, and outside agency approvals for construction as needed.
4. CONSTRUCTION DOCUMENT PHASE:
- a. The Architect shall consider options for and make recommendations regarding the most cost effective and efficient means of bidding the work such as bidding in segments, phases, or inclusive of all proposed work. Construction Documents shall be prepared accordingly.
  - b. The Construction Documents shall set forth in detail the design, function and construction to be used for the project. The development of the Construction Documents shall be responsive to the Schematic/Preliminary phase comments. The documents shall be appropriate for and sufficiently descriptive to secure bids for constructing the project and to direct the Contractor in the construction of the project. Electronic copies of the documents shall be provided. Specifications will be in MS Word format.
  - c. The Architect/Engineer shall be responsible for the technical correctness, code compliance, and internal document coordination of the project design documents.
  - d. Bid alternates where provided shall be developed as an integral part of the Construction Document. Bid alternates shall be clearly delineated in the documents and shall be appropriately detailed to describe the nature of the completed project whether the bid alternate is taken or not.
  - e. Meetings during this phase shall include a project kick off meeting, a mid-point review meeting, and a phase completion meeting.
  - f. The Architect/Engineer shall submit Construction Documents and a Construction Cost Estimate.
5. BIDDING:
- a. The County will publically advertise and bid the construction documents consistent with County procedures. The final Construction Cost Estimate will be used to evaluate the bids.
  - b. The design team will support the County in evaluating bids and in other administrative aspects of the construction bidding process.
  - c. Duties may include attending pre-bid conference as subject matter expert, answer pre-bid Requests for Information, respond to questions, prepare

addenda, review substitution requests, and assist in the pre-bid contractor interest campaign if needed.

6. CONSTRUCTION ADMINISTRATION:

The Architect/Engineer will provide ongoing consultation during construction including but not limited to: attending pre-construction meetings, reviewing and authorizing substitution requests, attending weekly County/Architect/Contractor meetings, responding to requests for information, issuing design bulletins as necessary, reviewing submittals, providing peer review of the construction deliverables, providing clarification for questions related to the design documents, reviewing pay applications, reviewing change order requests, and performing activities related to Construction Administration as needed.

7. GENERAL:

- a. Design to Budget: The initial construction cost budget is described by branch. The architect shall provide a base design targeted to 90% of the construction cost. Given the small project focus and the delay, rework and associated expense in addressing an overbid situation, an underbid result is desired. The Architect shall provide as part of this work additive bid alternate design enhancements for the project of approximately 5% of the construction cost budget. *It is the County's preference to seek the flexibility to be able to electively grow the project rather than to be compelled under time and budget pressures to extract costs.*
- b. Development permits are not anticipated for this work. If required, the Architect will provide plans at the end of the Preliminary Design Phase and the process will be coordinated by County Public Works Department staff.
- c. Interior Design: Interior design finishes for floors, walls and ceilings and the design of built-in casework is a part of this work
- d. Furnishings and Equipment: The architect shall develop a furniture layout and selection plan as described below for each branch. Purchasing and installation of moveable furnishings and equipment generally depicted therein is not part of the services.
- e. Hazardous Materials Abatement: Within the architects own work, the architect shall reference and provide support for the coordination of the separate hazardous material abatement design documents prepared by others.

- f. Coordination with public utilities: The Architect shall coordinate with public utilities including preparing any necessary applications and supporting documents and calculations.
- g. Work performed by others: Within the architects own work, the architect shall reference and provide coordination of separate design documents prepared by others as necessary.

## **PROJECT SCHEDULE**

A tentative project schedule is included as Attachment 1. The County intends for the Consultant to begin work upon award of the contract. The tentative schedule has been prepared based upon the sequential design and construction of the work by branch. The Consultant may suggest an alternative schedule which completes the work sooner.

## **EVALUATION CRITERIA**

A selection committee comprised of representatives of the SCCDPW and SCPL will evaluate all submittals and select the respondent that (1) best meets the needs as set forth in the RFQ; (2) is best qualified; and (3) is best able to provide the requested services for a reasonable fee and within the time limits. Award of a contract is contingent upon approval from the Santa Cruz County Board of Supervisors.

Consultant selection will be based on evaluation of the following:

- Project approach and understanding of the requested services (20 points)
- Qualifications of staff and relevant experience with the requested professional services, completeness of project team (20 points)
- Past experience and performance on similar projects related to quality of work, cost control, client communication, and timeliness (20 points)
- Approach for providing a cost-effective design and for maintaining cost controls throughout the project (20 points)
- Ability to work effectively and lead a team design process with input from the County, SCPL and the community (20 points)

## **SUBMITTAL REQUIREMENTS**

Each response to this RFQ shall not exceed 12 pages (double sided is acceptable for a total of 6 physical pages). Sheets 11x17 in size are acceptable for exhibits, drawings, etc. and will be counted as one page. Any attachments/appendixes (such as resumes and the Project Plan) will not be counted as part of the 12-page response limit.

The response should be succinct. The submitted material should focus on content that demonstrates experience and understanding in providing the requested consulting services.

Each response shall include the information described in this section. Failure to include all of the elements specified may be cause for rejection. Additional information may be provided, but should be succinct and relevant to the goals of this RFQ.

### **Cover Letter**

A one page cover letter shall be provided with the following information:

- Title of the RFQ
- Name and mailing address of firm
- Contact person, telephone number, fax number, and email address  
SCCDPW will use email to notify your firm of critical developments such as interview schedules, notification of selection/non-selection, etc.

The cover letter must be signed by an officer empowered by the Consultant to sign such material and thereby commit the Consultant to the obligations contained in the RFQ response. Further, the signing and submission of a response shall indicate the intention of the proposer to adhere to the provisions described in this RFQ and a commitment to enter a binding contract, if offered.

Responses submitted on behalf of a *Partnership* shall be signed in the firm name by a partner or the Attorney-In-Fact. If signed by the Attorney-In-Fact, there shall be attached to the response a Power-Of-Attorney evidencing authority to sign proposals, dated the same date as the response and executed by all partners of the firm.

Responses which are submitted on behalf of a *Corporation* shall have the correct corporate name thereon and the actual signature of the authorized officer of the corporation written (not typed) below the corporate name. The title of the office held by the person signing for the corporation shall appear below the signature of the officer.

Responses which are submitted by an *Individual* doing business under a firm name (“dba”) shall be signed in the name of the individual doing business under the proper firm name and style.

### **Firm’s Qualifications**

Describe the firm and provide a statement of the firm's qualifications for performing the requested consulting services. Indicate any specialized expertise relevant to libraries. Identify the services which would be completed by your firm's staff and those services typically provided by subconsultants. Identify subconsultants proposed to supplement your firm's staff.

### **Relevant Experience**

Provide a summary of the firm's experience with similar projects. The summary should include a minimum of three related projects, including dates and brief descriptions of the projects.

Include references for three of the projects stated in your summary, including date of project, contact person and phone number, and a brief description of the project that clearly demonstrates your firm's abilities.

Describe your firm's past record on controlling fees, delivering projects within the project cost estimate, quality of work, and established schedules by citing at least three examples of comparable projects. Identify the client, project name, project cost estimate, actual project cost, original project schedule, and completion time of the project.

### **Team Qualifications**

Provide a brief summary of the qualifications/experience of each team member, including length of service with the firm. Include the qualifications/experience of subconsultant staff on your project team. Provide an organization chart of the staff available for the project. Include a brief discussion of current project commitments and a table showing the percentage of time key staff members are available during the period of this contract (2017 through 2019).

### **Resumes**

As an appendix to the response, provide resumes for each team member. No more than one page shall be used per resume, except for the principals, which may not exceed two pages each and no more than three principals may be listed (i.e. Project Manager, Principal in charge, etc.)



## **Project Plan**

Provide as an attachment to the submittal, a narrative on how your firm would approach a scope of work for providing architectural, interior design, engineering, and cost estimating for the requested planning, design and construction administration support services described in this RFQ. Outline how your firm will interact with SCCDPW and SCPL during the course of the project. Describe how your firm can assure timely completion of such a project. A tentative schedule is included as an attachment. The Project Plan shall demonstrate the required knowledge and experience to complete the project. It should describe the anticipated requirements, approaches and methodology to be used, anticipated work to be performed, suggested approach and suggested schedule for completing the work at three branches, outcomes, and work products.

## **Fee Schedule**

Include your fee schedule with the response. The fee schedule shall include billing rates for staff at the various levels which may perform work on the project as well as an estimate of direct and indirect costs. Billing rates for subconsultants shall also be included, with markups if applicable.

The fee schedule shall be submitted in a separate sealed envelope and will not be opened until the technical review of your proposal has been completed.

## **STANDARD TERMS AND CONDITIONS**

### **Standard Consulting Agreement:**

The Consultant selected to provide the scope of services shall sign the County's standard *Independent Contractor Agreement (Design Professionals)*, and will be required to provide evidence of insurance for the coverage specified in the agreement. A sample of this agreement is attached to this RFG. The final scope of work and fee will be negotiated and included in the agreement, in accordance with the fee schedule provided by the consultant in response to this RFQ. By submitting a proposal for the work, the Consultant agrees to be bound by the sample agreement form for the contract.

### **Indemnification and Insurance Requirements:**

Refer to Attachment A5, sample Independent Contractor Agreement paragraphs 7 and 8 for indemnification and insurance requirements. SCCPDW reserves the right to withhold payments to the Consultant or cancel Contact in the event of non-compliance with the insurance requirements provided herein. CONTRACTOR agrees to provide its insurance broker(s) with a full copy of these insurance requirements and provide

COUNTY on or before the effective date of this contract Certificates of Insurance for all required coverages.

If you do not currently carry the type/limit of insurance stated herein, please submit your RFQ with any differences clearly noted. Indicate if you would be able to obtain the proposed insurance.

**Proprietary Information:**

All information appearing within and as attached to a response is public information and may be subject to public inspection. Any proprietary information must be clearly marked as such and submitted in a separate sealed envelope and referenced only within the body of the response. The County and the Public Works Department are subject to the California Public Records Act (CPRA) and the California Public Contract Code, and cannot guarantee that proprietary materials submitted under seal will remain confidential.

**Nondiscrimination:**

The SCCDPW does not unlawfully discriminate in violation of any federal, state or local law, rule or regulation because of race, religious creed, color, national origin, ancestry, physical or mental disability, medical condition, genetic information, pregnancy related condition, marital status, gender/sex, sexual orientation, gender identity, gender expression, age (over 40), political affiliation or belief, or military and veteran status.

No person shall be excluded from participation in, denied benefits of, discriminated against in the admission or access to, or discriminated against in treatment or employment in the SCCDPW's contracted programs or activities on the grounds of disability, age, race, color, religion, sex, national origin, or any other classification protected by federal or California State constitutional or statutory law. Additionally, no person shall be excluded from participation in, denied benefits of, or otherwise subjected to discrimination in the performance of contracts with the SCCDPW or in the employment practices of the SCCDPW's proposers. Accordingly, all proposers entering into contracts with the SCCDPW shall, upon request, be required to show proof of such nondiscrimination and to post in conspicuous places, available to all employees and applicants, notices of nondiscrimination.

**Protest and Appeals Procedures:**

Respondents are referred to the Attachments for the Department of Public Works Protest and Appeals Procedures.

## **SELECTION PROCEDURE**

It is the intent of the SCCDPW to select and contract with a consultant team led by an architect for these services.

The SCCDPW shall select the Consultants based on the following procedure:

- Receive and evaluate the responses and develop a short list of the top two to three consultants.
- If necessary, select and notify the consultants on the short list to be interviewed.
- Develop final ranking of the Consultants.
- One Consultant will be selected and negotiations will be initiated.
- Notify the Consultants of the results.

Consultants will be chosen based on qualifications and the quality of their response.

The SCCDPW reserves the right to contract with additional consultants. The SCCDPW reserves the right to reject any and all responses to this RFQ and to take other actions as outlined in the Reservations attached to this RFQ

## **SUBMITTAL INSTRUCTIONS**

Only that information specifically requested shall be submitted. If a Consultant recognizes a more efficient method of accomplishing specific tasks or items, the Consultant's fees shall reflect the SCCDPW's requested work, and the cost increase/savings for the more efficient method shall be noted separately.

**If you wish to be considered for this solicitation, submit four (4) hard copies of your response by 5:00 p.m., on August 30, 2017 to:**

Betsey Lynberg  
 Director of Capital Projects  
 County of Santa Cruz Department of Public Works  
 701 Ocean Street, Room 410  
 Santa Cruz, CA 95060

Also, provide an electronic copy of your response (not including the contents inside the sealed Fee Schedule envelope) in PDF format.

The successful firms shall be required to enter into an *Independent Contractor Agreement (Design Professionals)* with SCCDPW for the work to be performed. A sample *Independent Contractor Agreement (Design Professionals)* is included with this Request for Qualifications. The consultant shall state in the submitted response that the firm has reviewed the *Independent Contractor Agreement (Design Professionals)*, will

meet all of the terms and conditions if selected by the SCCDPW for the requested services, and will be able to sign the agreement as-is with no changes.

A copy of this Request for Qualifications is available for viewing and download on the Santa Cruz County's website at [www.ebidboard.com](http://www.ebidboard.com). Please contact Betsey Lynberg at [Betsey.Lynberg@santacruzcounty.us](mailto:Betsey.Lynberg@santacruzcounty.us) or assistance using the website if needed. All questions regarding the RFQ must be submitted **in writing**. Questions shall be submitted to Betsey Lynberg at [Betsey.Lynberg@santacruzcounty.us](mailto:Betsey.Lynberg@santacruzcounty.us). Addendums, if necessary, will be posted on the aforementioned website.

## Attachment A1

## TENTATIVE PROJECT SCHEDULE

BRANCH	PHASE	TENTATIVE TIMEFRAME
<b>La Selva Beach Branch</b>	Schematic/Preliminary Design	December 2017 – April 2018
	Development Permit and Lease Amendment as necessary (by County)	April – September 2018
	Construction Documents and Approvals	July – December 2018
	Bid & Award	January – March 2019
	Construction	April – September 2019
<b>Boulder Creek Branch</b>	Schematic/Preliminary Design	May – August 2018
	Construction Documents and Approvals	September 2018 – February 2019
	Bid & Award	March - June 2019
	Construction (begin pending completion of the Felton Branch Library)	August 2019 – January 2020
<b>Live Oak Branch</b>	Schematic/Preliminary Design	September - December 2018
	Development Permit Amendment, as necessary (by County)	January – June 2019
	Construction Documents and Approvals	May – October 2019
	Bid & Award	November 2019 – January 2020
	Construction (begin pending completion of the Capitola Branch Library)	February – July 2020



Attachment: 2017-SCCDPW Library Renovation RFQ (Approval of RFQ for the Santa Cruz County Library Renovation Project)

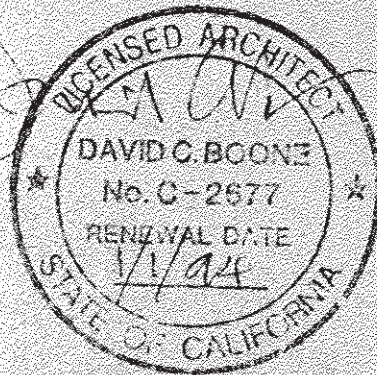
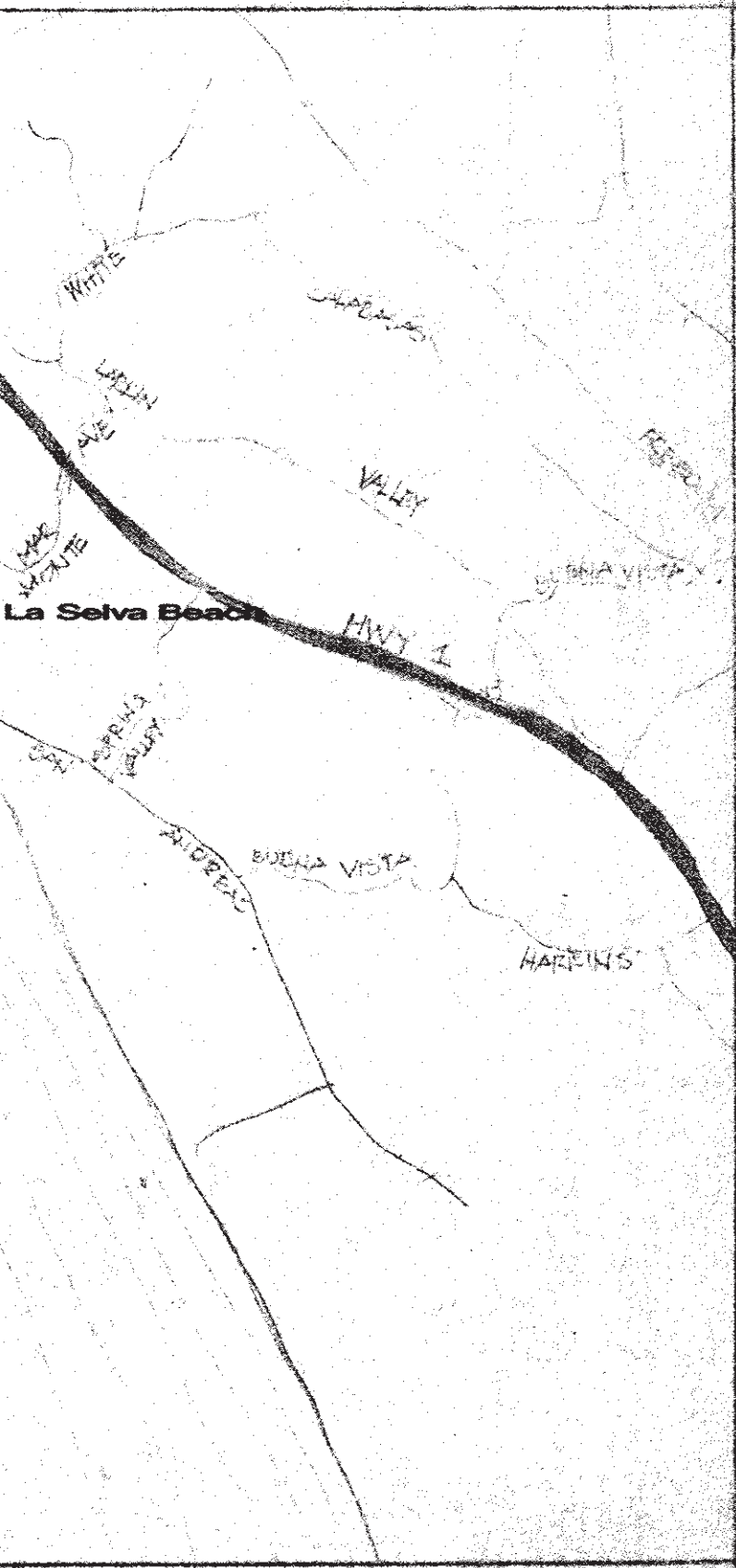

06/30/

SHEET

1

# LA SELVA BEACH LIBRARY ADDITION

## LA SELVA BEACH RECREATION DISTRICT

EXIS  
CAR  
COT



### WINDOW SCHEDULE

SYMB	W	H	TYPE	
①	4'-0"	4'-0"	SLIDER	CLE AND ALL
2	6'-0"	4'-0"	SLIDER	
3	±7'-2"	5'-0"	FIXED	
4	±7'-2"	5'-0"	FIXED	
5	±7'-2"	5'-0"	FIXED	
6	±7'-2"	5'-0"	FIXED	
7	4'-0"	4'-0"	SLIDER	
8	4'-0"	4'-0"	SLIDER	
9	2'-6"	6'-0"	FIXED	

⚠ DELETE

⚠ DELETE

⚠

ALL WINDOWS TO HAVE FLAT

### DOOR SCHEDULE

DOOR NO.	DOOR			TYPE
	W	H	TH	
A	2'-0"	6'-8"	1 3/8"	S.C
B	3'-0"	6'-8"		
C	3'-0"	6'-8"	↓	↓
D	2'-8"	6'-0"	↓	HC

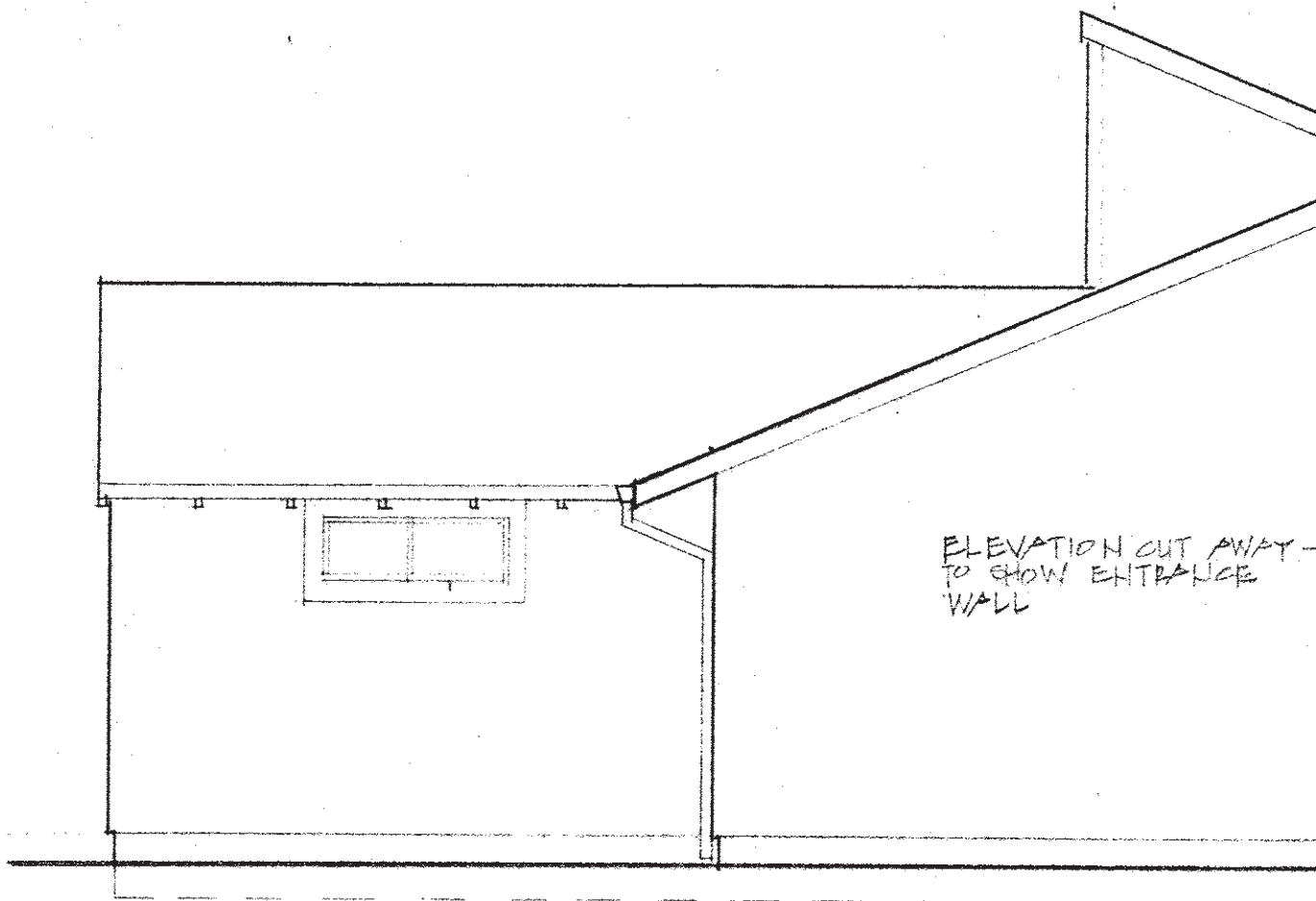

ELEVATION CUT AWAY  
TO SHOW ENTRANCE  
WALL

FOUNDATION SHOWN  
DASHED

WEST ELEVATION

EXISTING WOOD  
DECKING IN  
EXPOSED CEILING

EXISTING 8/11 GYP RD.  
CEILING - PATCH AS REQD.

5  
X

O

O

RE  
FIX

EX  
RAY  
EX

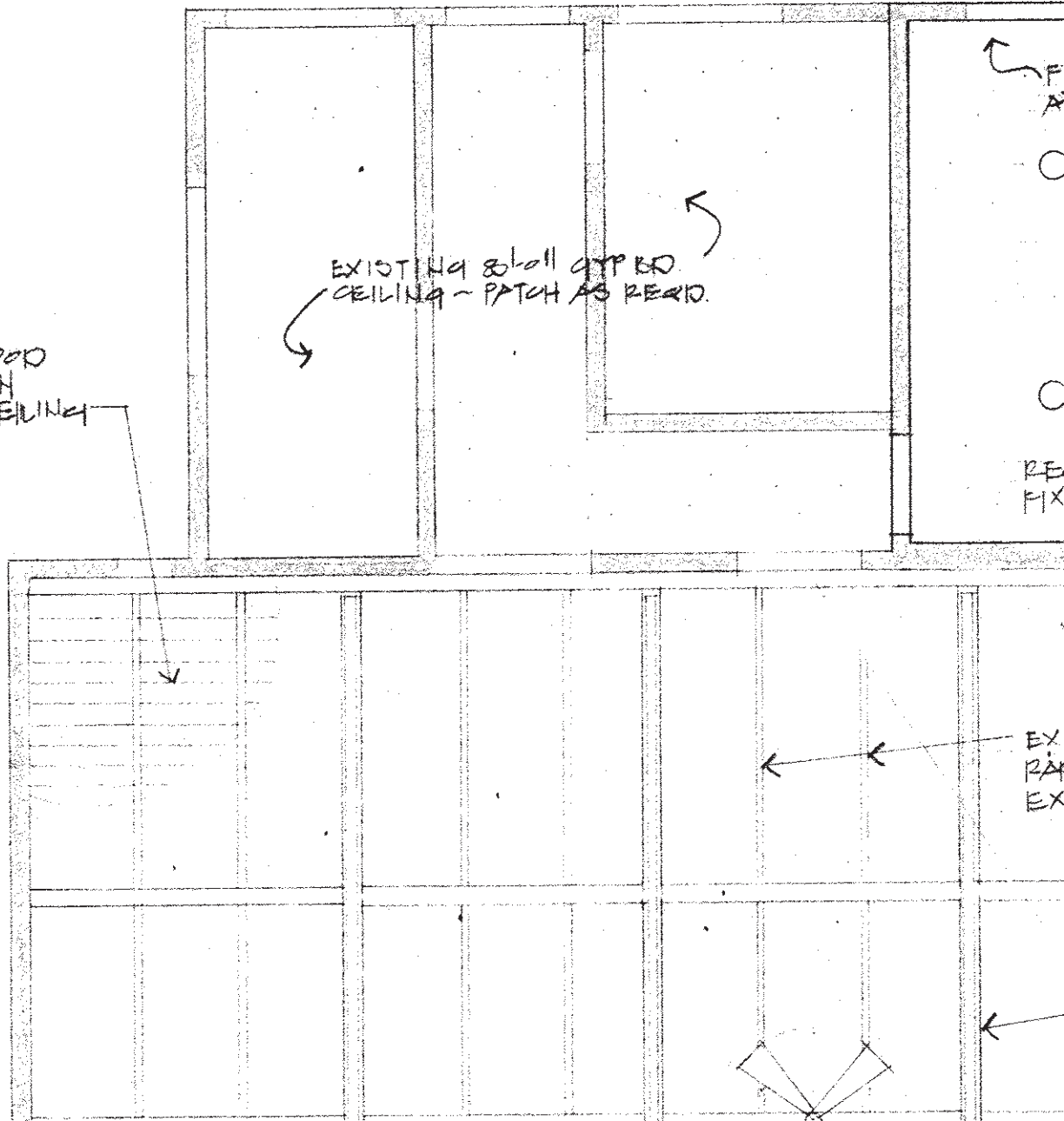

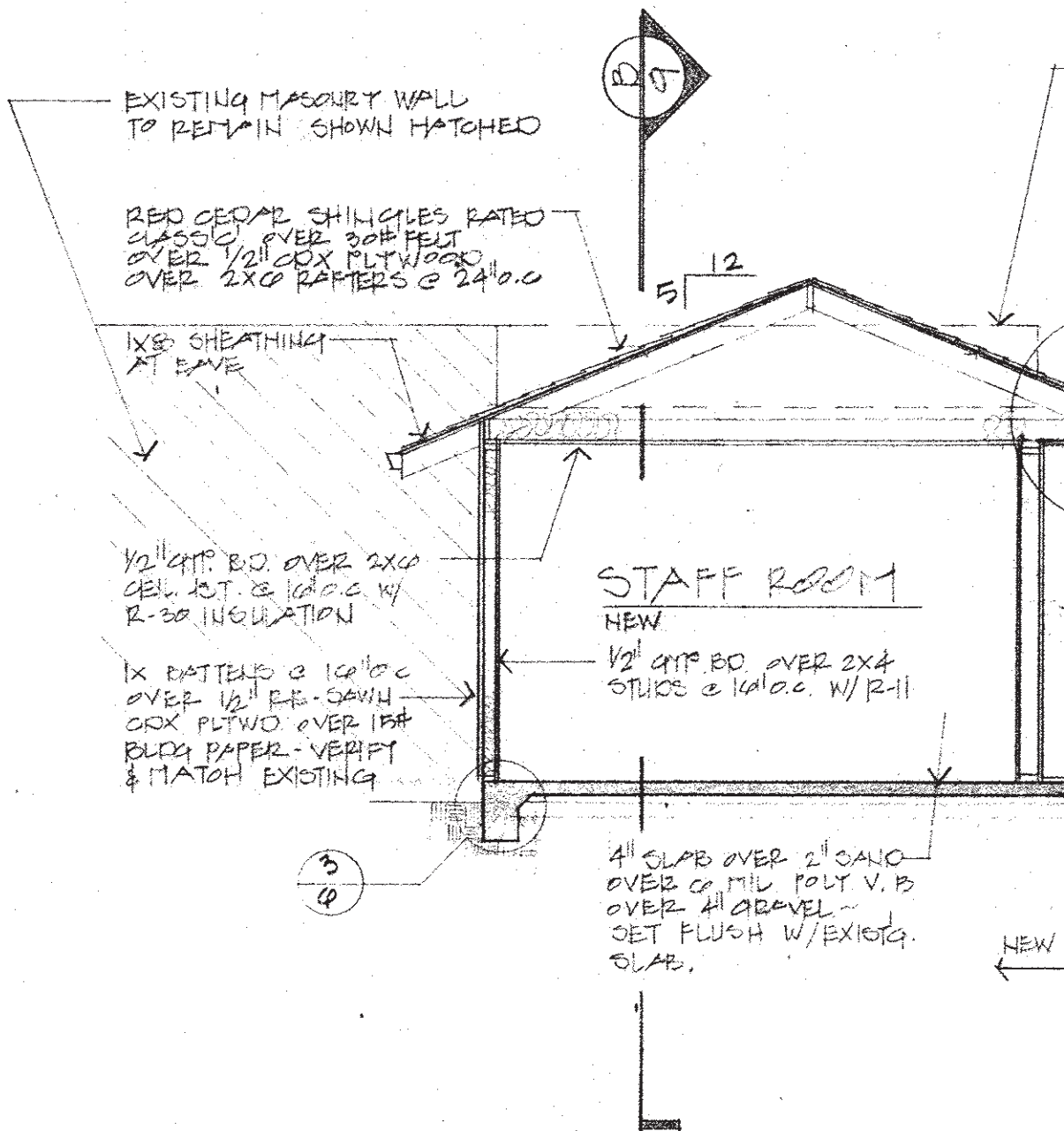

EXISTING MASONRY WALL  
TO REMAIN SHOWN HATCHED

RED CEDAR SHINGLES RATED  
CLASSIC OVER 30# FELT  
OVER 1/2" COX PLTWOOD  
OVER 2X6 RAFTERS @ 24" O.C.

1X8 SHEATHING  
AT EAVE

1/2" GYP. BD. OVER 2X6  
CEL. JST. @ 16" O.C. W/  
R-30 INSULATION

1X BATTENS @ 16" O.C.  
OVER 1/2" EE-SAWN  
COX PLTW. OVER 15#  
BLDG PAPER - VERIFY  
& MATCH EXISTING

STAFF ROOM  
NEW

1/2" GYP. BD. OVER 2X4  
STUCCO @ 16" O.C. W/R-11

4" SLAB OVER 2" SAND  
OVER 6" MIL. POLY. V. B.  
OVER 4" GRAVEL -  
SET FLUSH W/EXISTG.  
SLAB.

NEW

3  
4

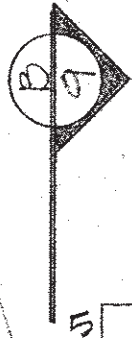

5 12

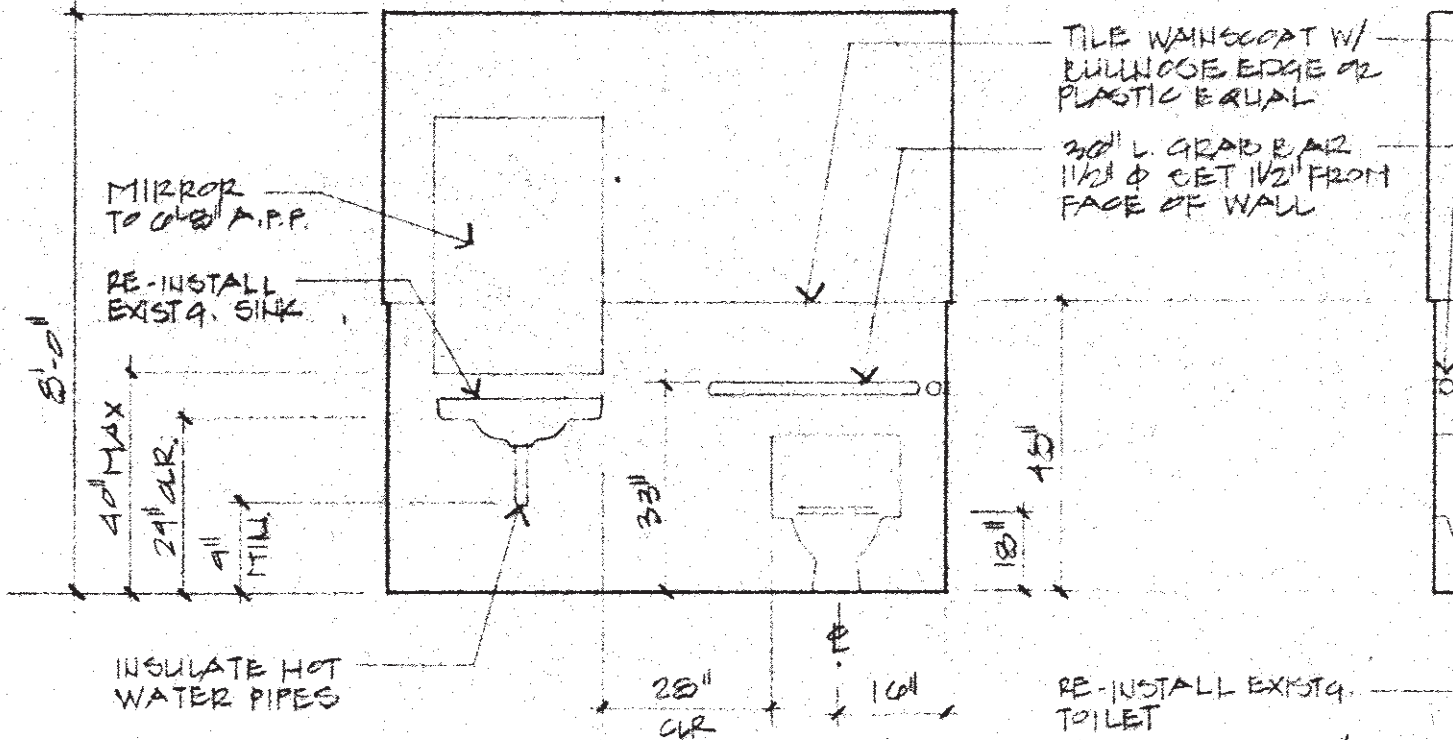

①

# RESTROOM ELEVATIONS

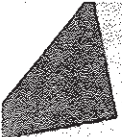

Handwritten signature and a vertical line on the right edge of the page.

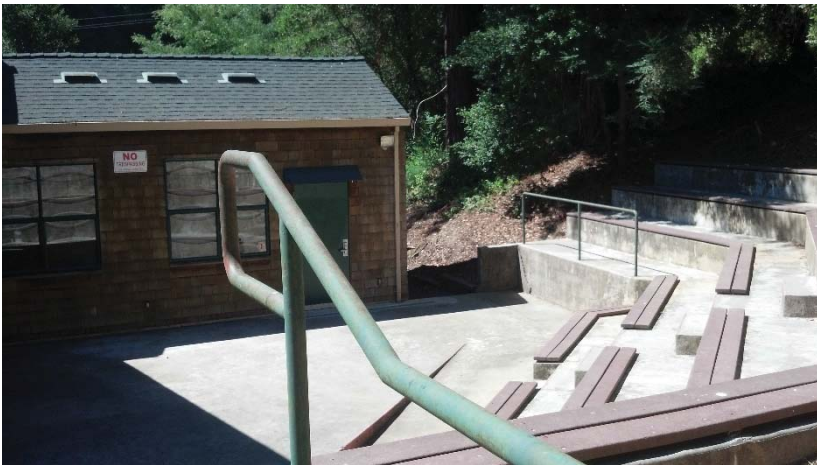

Attachment: 2017-SCCDPW Library Renovation RFQ (Approval of RFQ for the Santa Cruz County Library Renovation Project)

BO

Site Location Map

PROJECT  
SITE

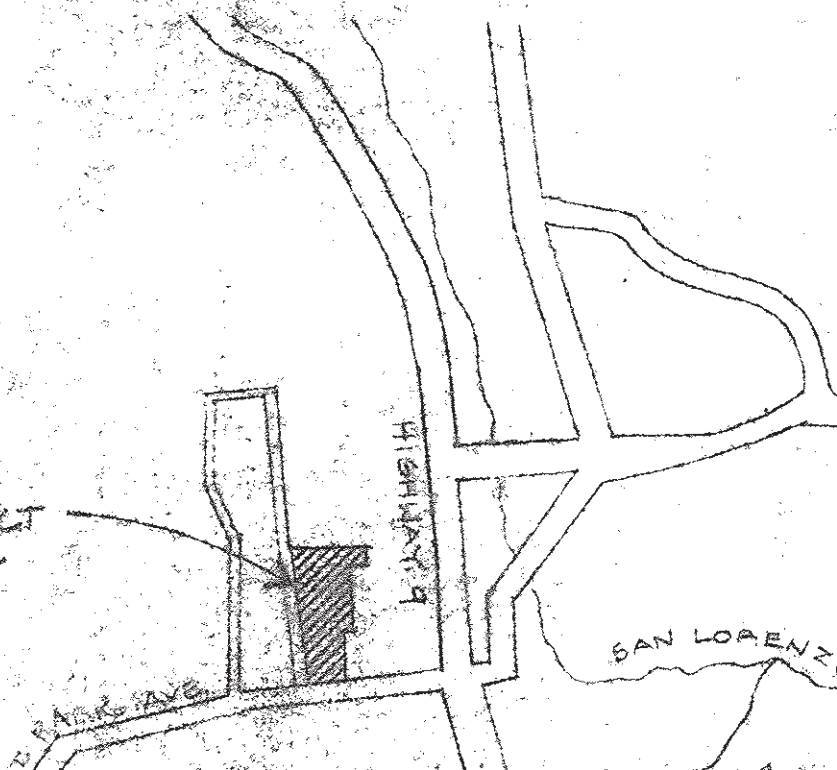



500 501 502 503 504 505 506 507 508

20.01 TO C  
OF STREET

499

FIRE HYDRANT

498

RWE

497

496

495

5 04' 16" W  
24.50'

494

493

6' curb

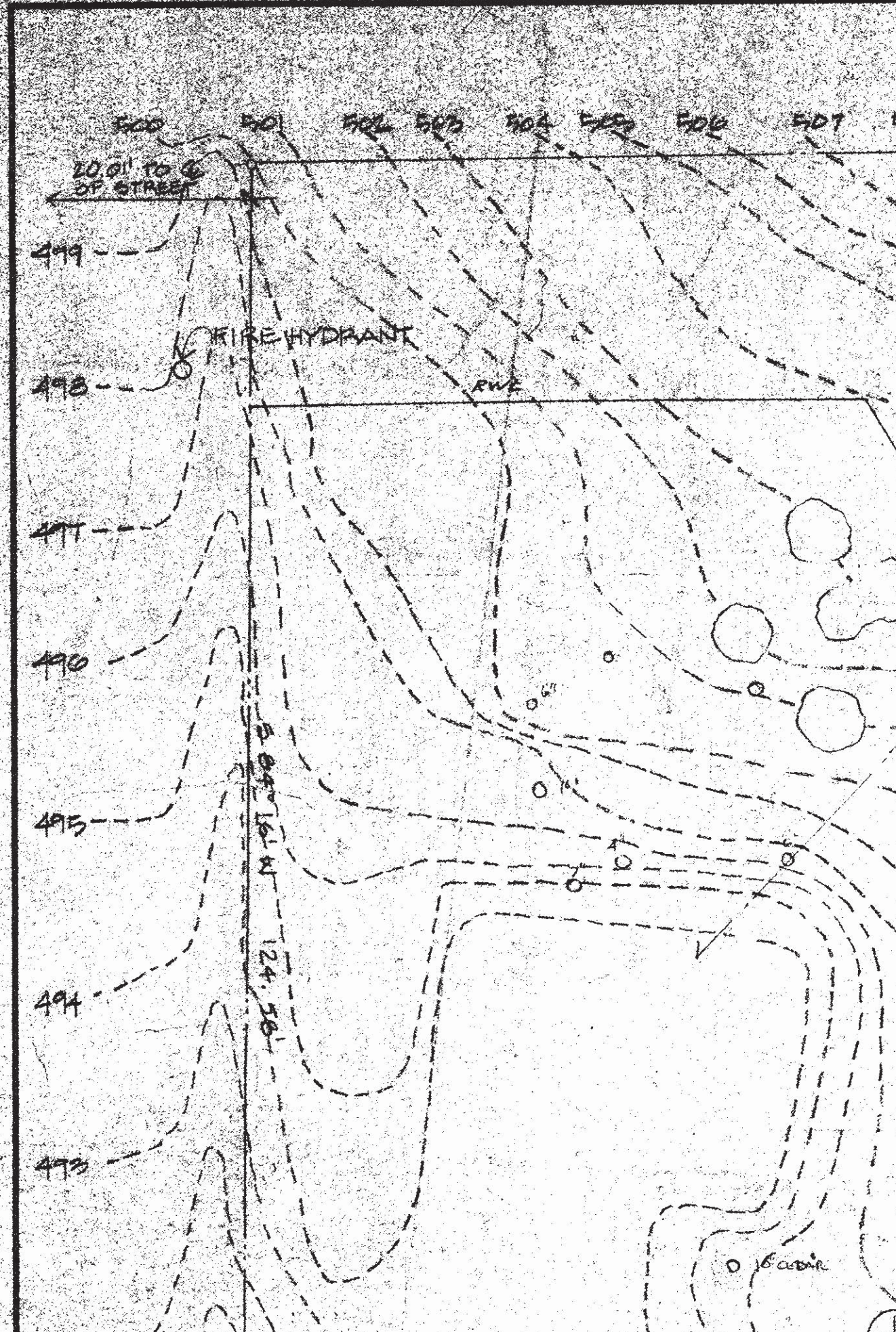

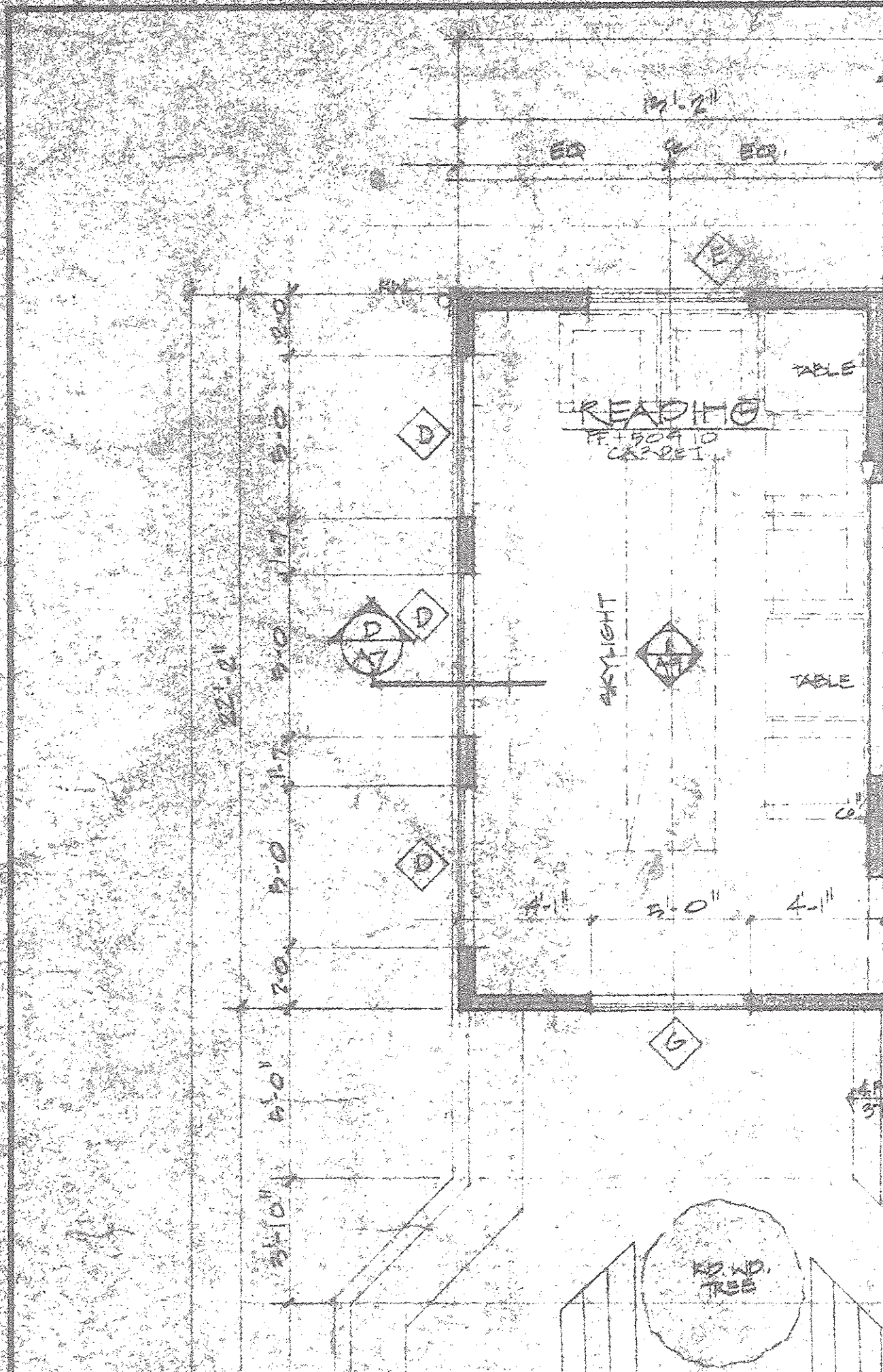

12'-2"

EQ

EQ

D

TABLE

READING

F. 509 10  
CR2 DEI

D

D

SKYLIGHT

D

TABLE

D

CO

4'-0"

5'-0"

4'-0"

5'-0"

G

ROUND TREE

TO PLATE  
+517.5'

TO PLATE  
+513.33'

S.F.A. ELEV.  
+504.01

4'-2"

1'-4"

SWALE

R.W.L.

UNDERDRAIN

2'-0"

D

SKYLIGHT

SHINGLES

FWD PL

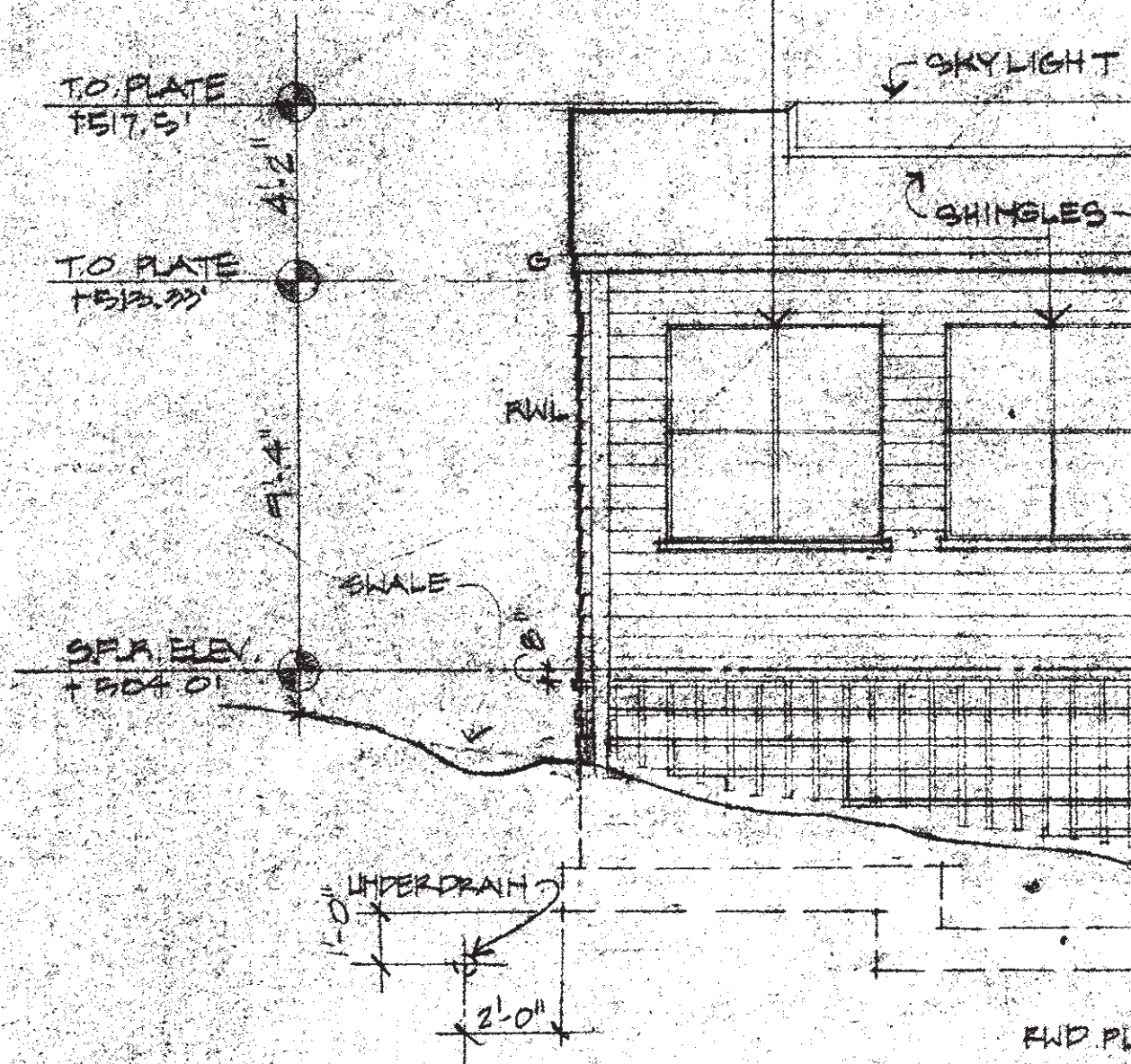

TO PLATE  
+ 913.331

S. PLR. ELEV.  
+ 504.0'

9'-4"

B.B.

4'-5"

3'-4"

6  
INCH

1x2 RDWD. LATTICE  
OVER RD. ND. FLY

6" CONC. CURB  
FTG'S 1'-6" BE

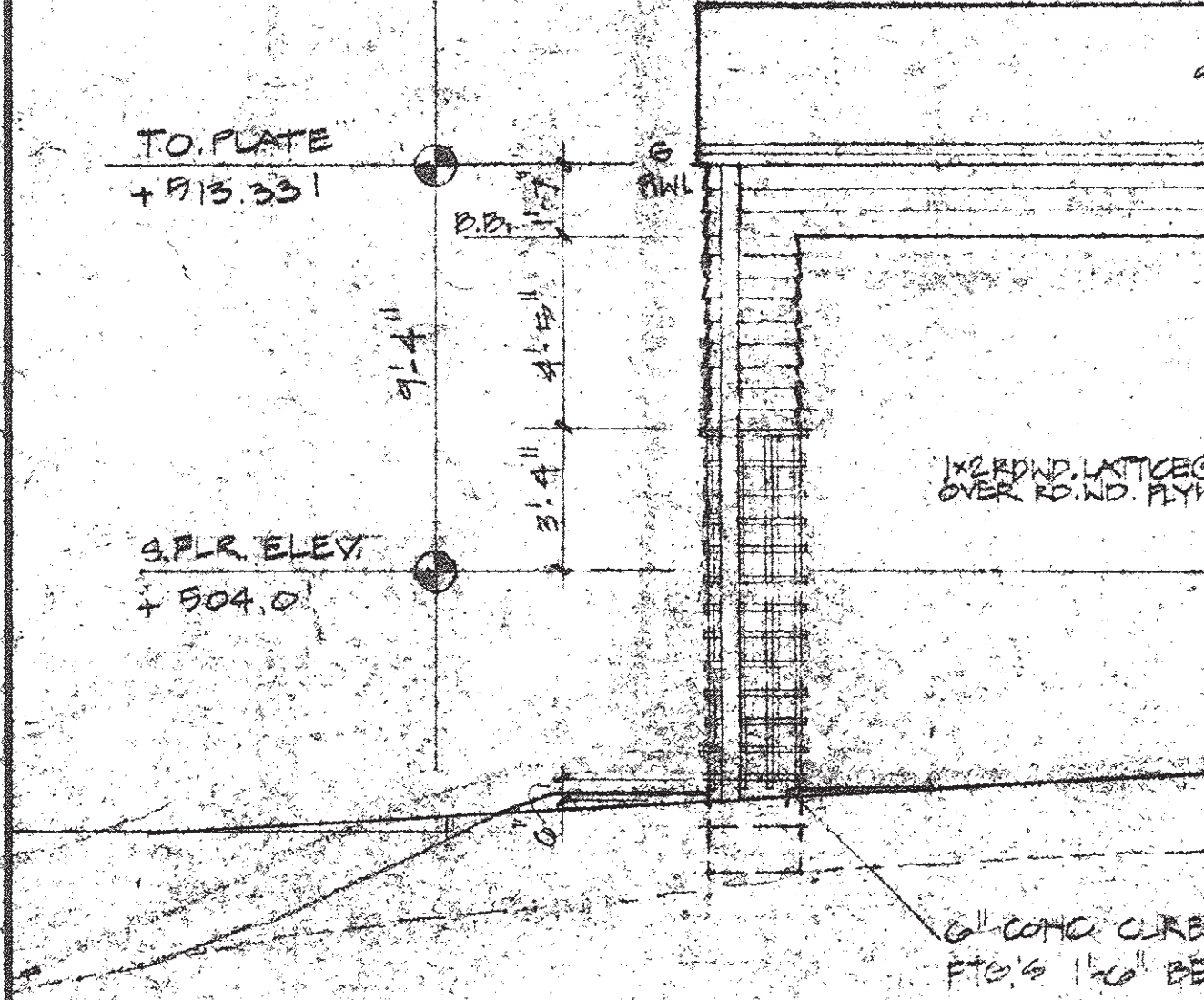

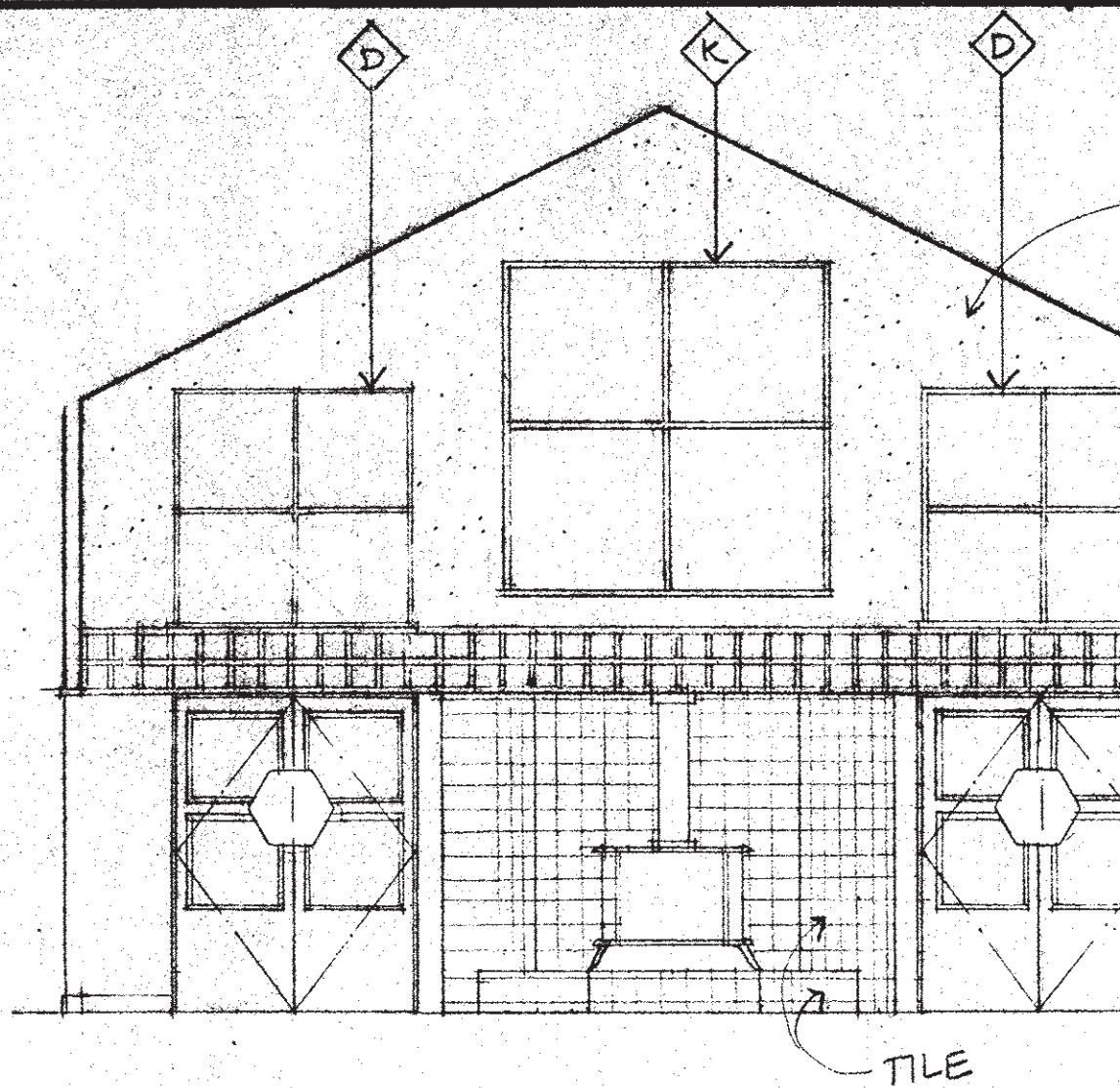

1  
A8

SOUTH REFERENCE AREA

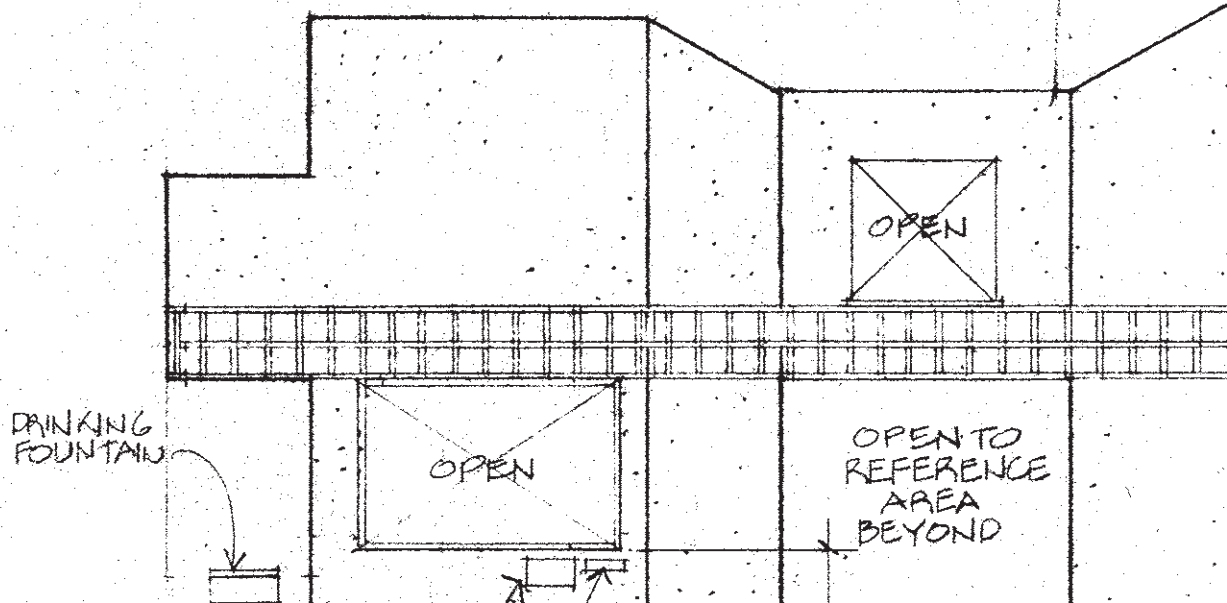

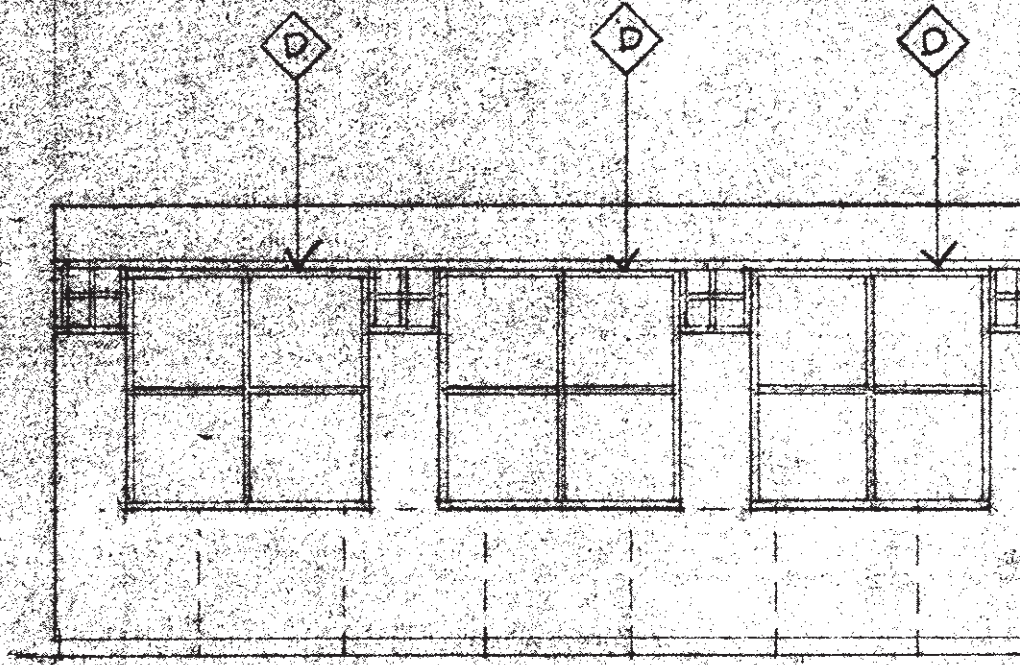

1  
 A9 SOUTH  
 READING ROOM ELEVATION  
 (CHILDREN READING ROOM)

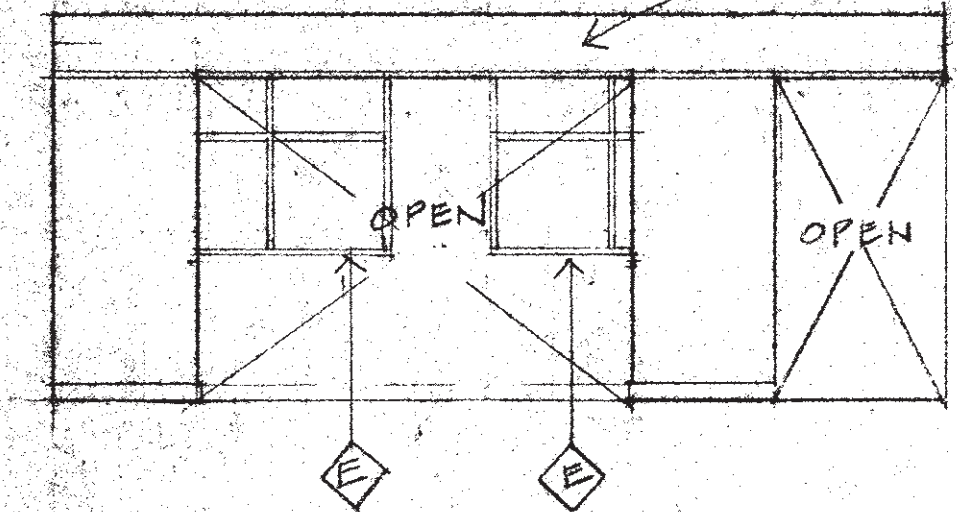

3  
 A9 NORTH  
 STACKS





Attachment: 2017-SCCDPW Library Renovation RFQ (Approval of RFQ for the Santa Cruz County Library Renovation Project)

# CODE ANALYSIS

CONSTRUCTION TYPE V-NON RATED

## APPLICABLE CODES

ARCHITECTURAL: 2001 CALIFORNIA BUILDING CODE

STRUCTURAL: 2001 UNIFORM BUILDING CODE

FIRE CODE:

MECHANICAL: 2001 CALIFORNIA MECHANICAL CODE

ELECTRICAL: 2001 CALIFORNIA ELECTRICAL CODE

PLUMBING: 2001 CALIFORNIA PLUMBING CODE

ACCESSIBILITY: 2001 CALIFORNIA BUILDING CODE

## OCCUPANCY

## ALLOWABLE AREA (TABLE 5-B)

B (TYPICAL)

8,000 SF

## ALLOWABLE AREA INCREASES (TOTAL BUILDING AREA = 14,538 GSF)

505.1.2 SEPARATION ON THREE SIDES: (100% INCREASE)

B 8000 SF =

16,000 SF (\*32,000 SF)

\* SEE 'FIRE SUPPRESSION SYSTEMS'

## FIRE SUPPRESSION SYSTEMS (CBC SEC. 505.3)

THE AREA'S SPECIFIED IN TABLE 5-B MAY BE DOUBLED IN BUILDINGS OF MORE THAN ONE STORY IF THE BUILDING IS PROVIDED WITH AN APPROVED AUTOMATIC SPRINKLER SYSTEM THROUGHOUT.

AN AUTOMATIC FIRE SPRINKLER SYSTEM HAS BEEN PROVIDED PER NFPA 13.

THE AUTOMATIC FIRE SPRINKLER SYSTEM WILL BE SUPERVISED.

FIRE EXTINGUISHERS HAVE BEEN PROVIDED TO BE WITHIN 75 FEET TRAVEL FROM ANY POINT.



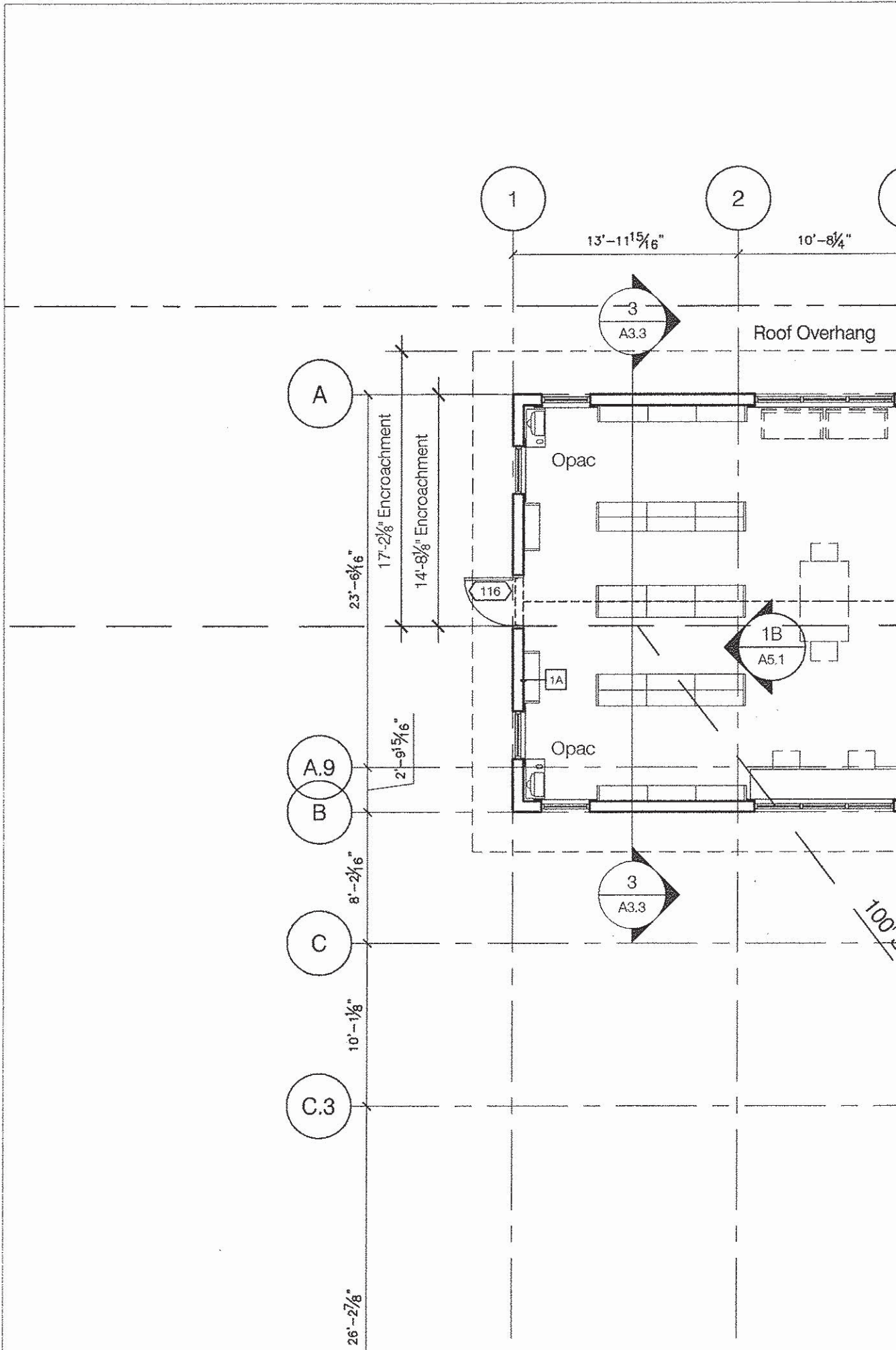

1

2

13'-11 5/16"

10'-8 1/4"

3  
A3.3

Roof Overhang

A

23'-6 1/16"

17'-2 1/8" Encroachment

14'-8 1/8" Encroachment

Opac

116

1B  
A5.1

Opac

A.9

B

2'-9 5/16"

8'-2 1/16"

C

3  
A3.3

10'-1 1/8"

C.3

26'-2 7/8"

100%

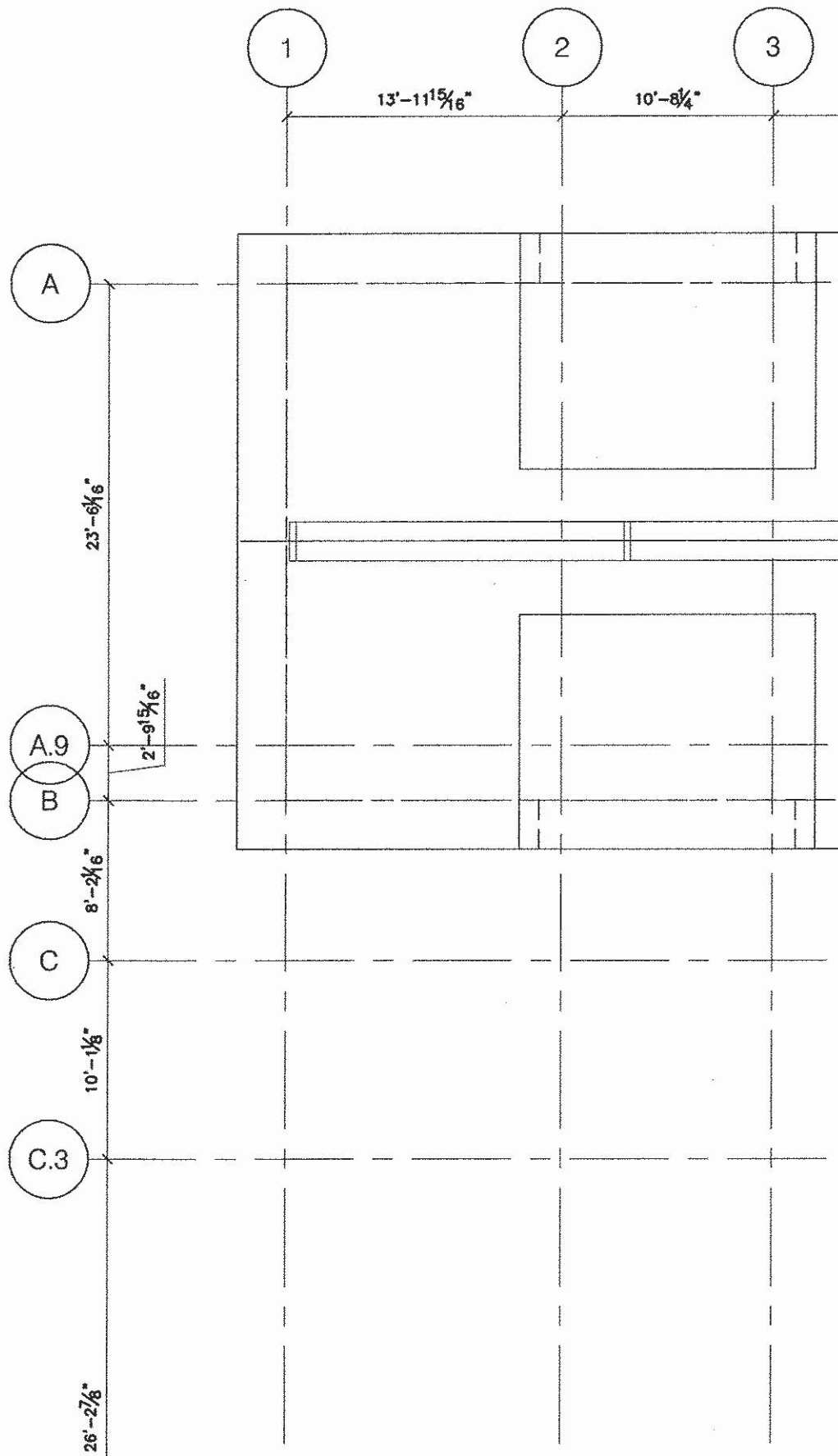

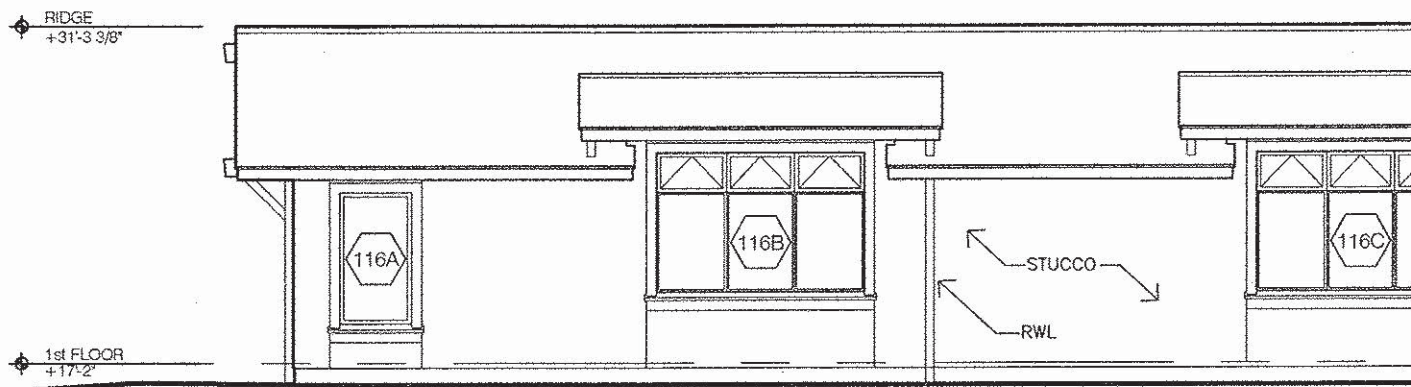
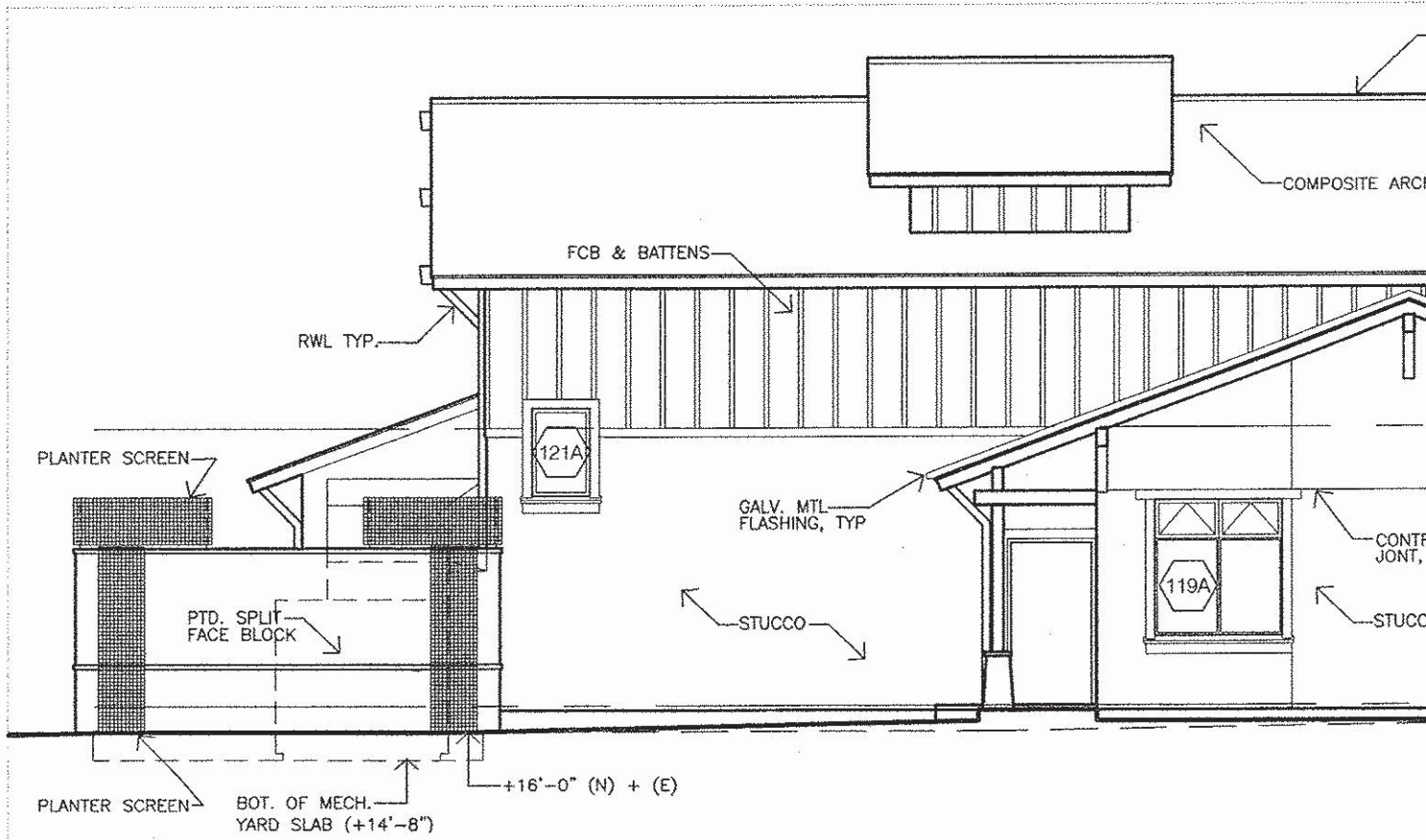

8

South Elevation: Room 116

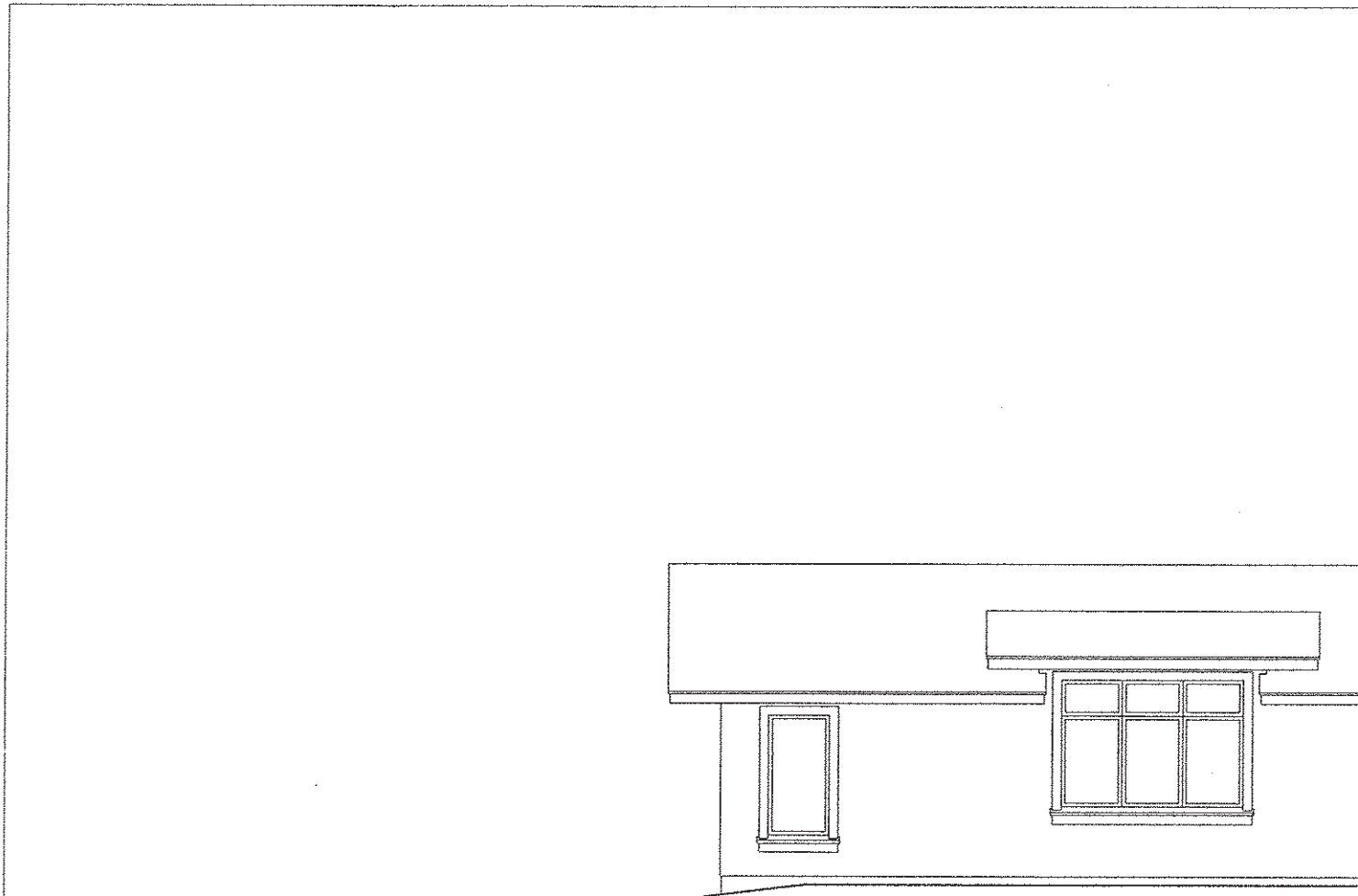

+14'-6" (E)  
+13'-7" (N)

GRADE BEYOND

(N) PARKING  
GRADE

(N) SIDEWALK  
(N) CONC

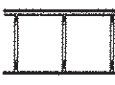

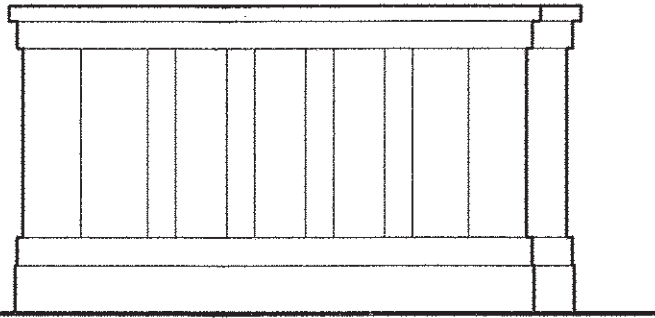

13 Reference Desk Side Elevation  
1/2" = 1'-0"

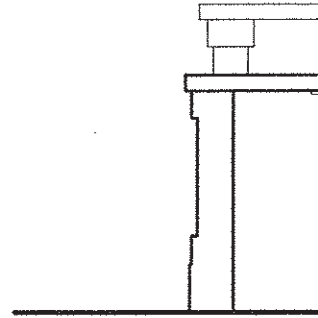

9 Refer  
1/2" = 1'

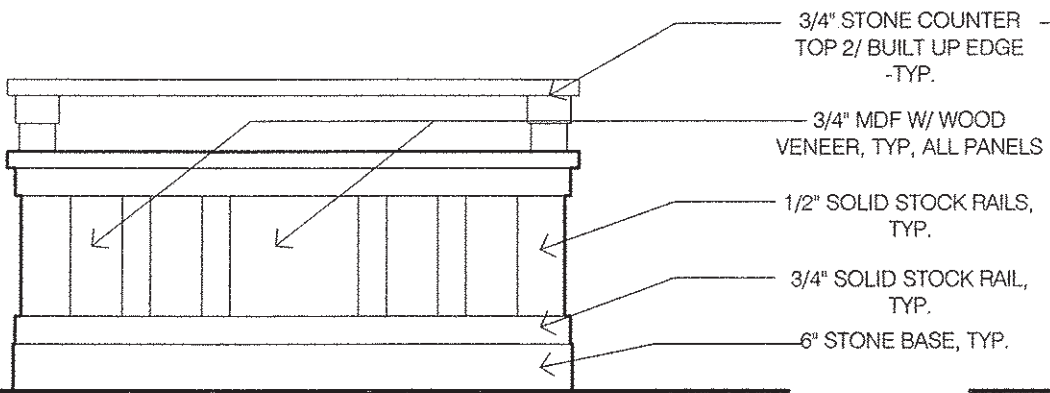

12 Reference Desk Side Elevation  
1/2" = 1'-0"

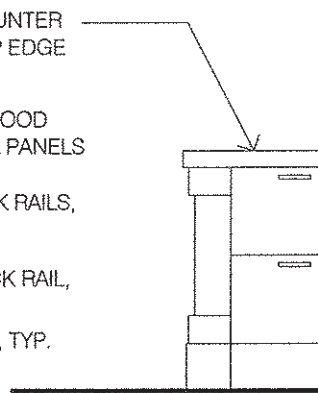

8 Refer  
1/2" = 1'

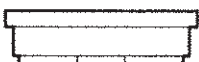

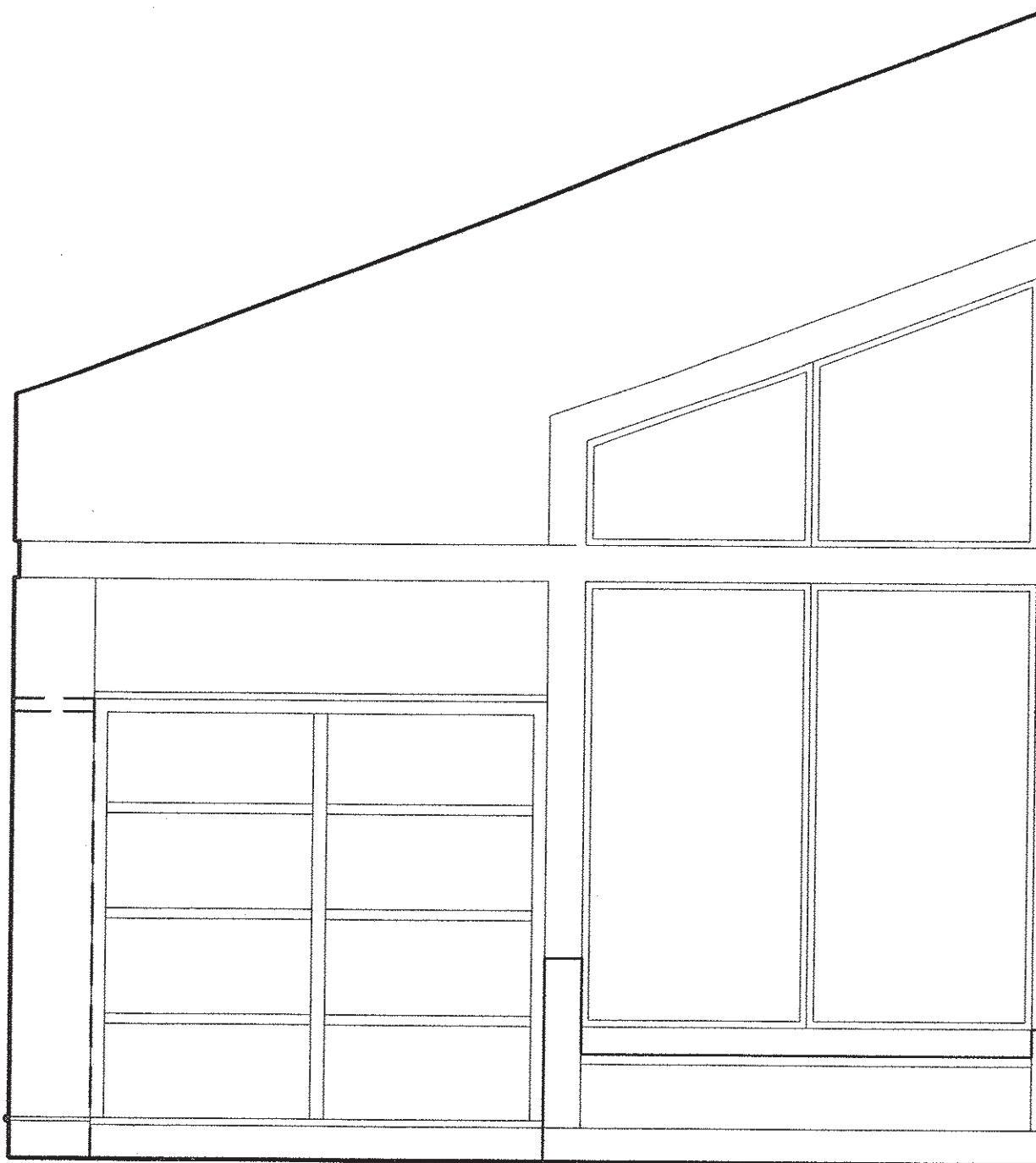

13

Picture Book Built-in shelving and Bench Elevation

1/2" = 1'-0"

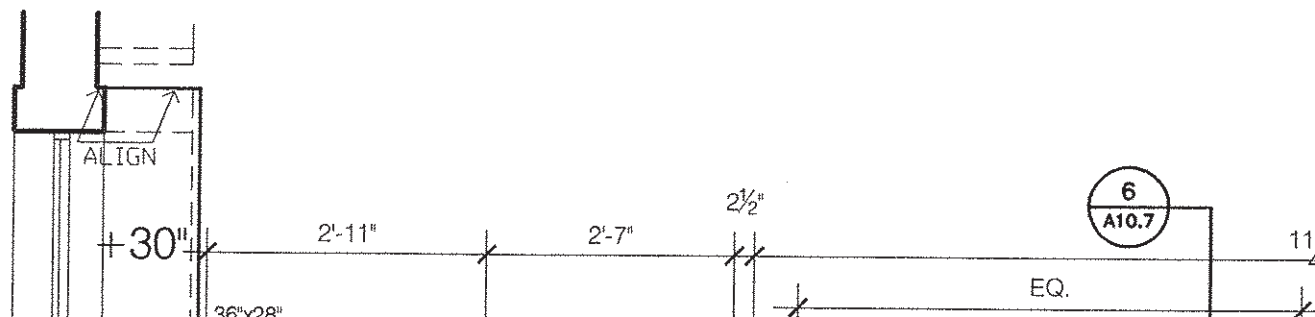

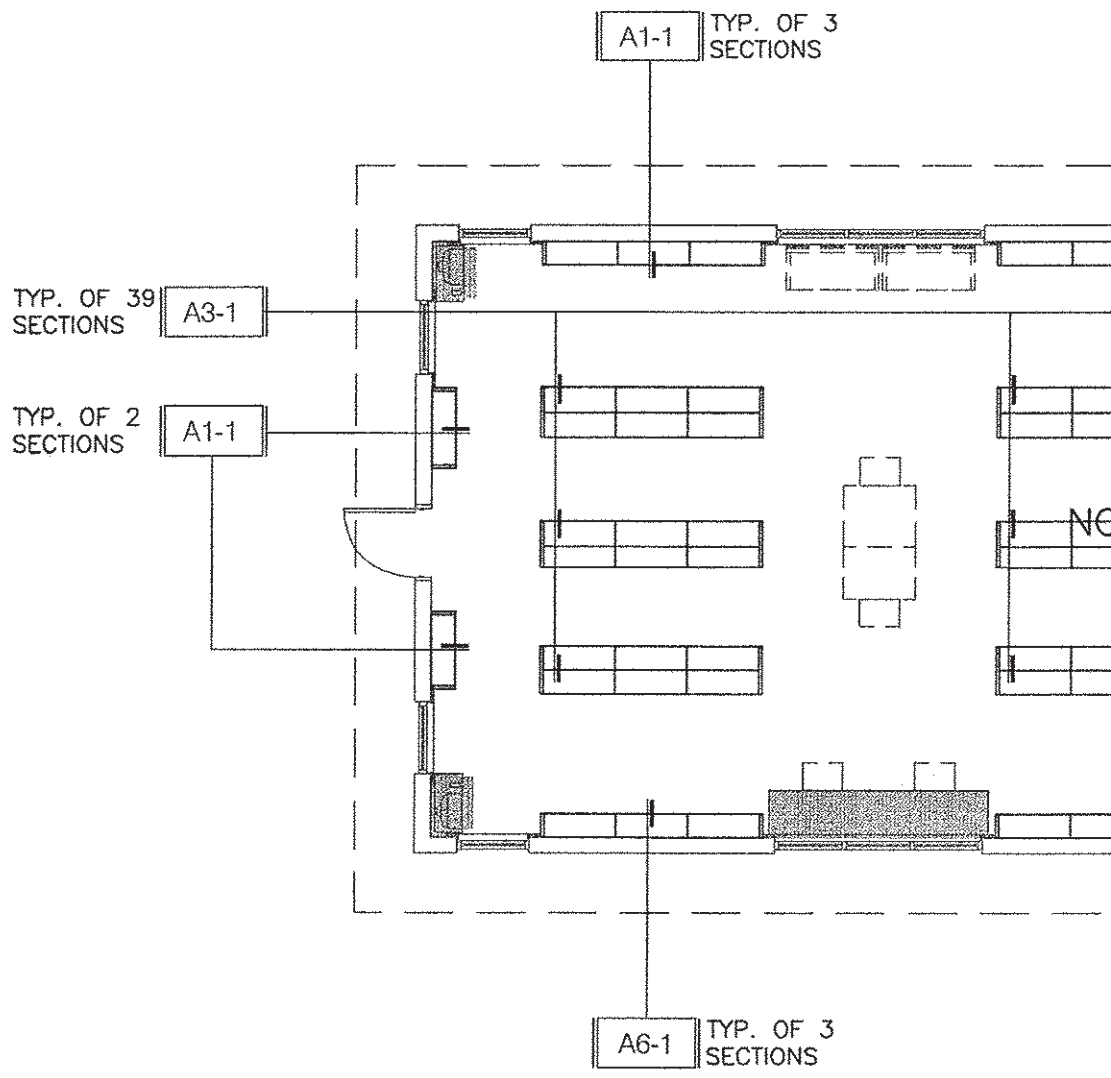

TYP. OF 2 SECTIONS

TYP. OF 5 SECTIONS

TYP. OF 3 SECTIONS

TYP. OF 3 SECTIONS

## Attachment A5

Contract No. \_\_\_\_\_

**INDEPENDENT CONTRACTOR AGREEMENT**  
**(DESIGN PROFESSIONALS)**

This Contract, which is effective on the date it is fully executed, is between the COUNTY OF SANTA CRUZ, hereinafter called COUNTY, and (enter contractor name), hereinafter called CONTRACTOR. The parties agree as follows:

1. **DUTIES.** CONTRACTOR agrees to exercise special skill, in accordance with customary and ordinary professional practices and principles accepted in the industry, to accomplish the following results: (enter scope of work) for the County of Santa Cruz (enter department name) Department (hereinafter “the project”).

2. **COMPENSATION.** In consideration for CONTRACTOR accomplishing said result, COUNTY agrees to pay CONTRACTOR as follows: Payment not to exceed \$(enter amount of contract), processed for payment in full after project completion, receipt of invoice, and approval of project manager [OR] after receipt and project manager approval of monthly invoices based upon the amount of actual progress achieved during the preceding month.

3. **TERM.** The term of this Contract shall be: (first date of contract) through (last date of contract), or completion of the project, whichever is later.

4. **DESIGN DOCUMENTS.** All design documents prepared by CONTRACTOR shall comply with applicable laws, statutes, ordinances, codes, rules and regulations. Original design drawings and specifications are the property of CONTRACTOR; however, COUNTY shall be furnished with reproductions of drawings and specifications produced pursuant to this Contract. Reproductions shall be the property of the COUNTY, which may use them without CONTRACTOR’s permission for any purpose relating to the project, including construction of the work of improvement.

5. **SCHEDULE.** CONTRACTOR shall complete the project as expeditiously as is consistent with professional skill and care, and the prompt, orderly progress of the project. The total amount of compensation accounts for time necessary for review and revision of design drawings and specifications by COUNTY and other entities or authorities with jurisdiction over the project, if any, and no additional compensation shall be due for delays attributable thereto. No additional services or work made necessary, in whole or in part, by any fault or omission of CONTRACTOR to perform its duties, responsibilities or obligations under this Contract, shall be compensated as extra work.

6. **EARLY TERMINATION.** COUNTY may terminate this Contract at any time by giving thirty (30) days’ written notice to the CONTRACTOR. CONTRACTOR may terminate this Contract only for cause, after providing COUNTY thirty (30) days’ written notice and opportunity to cure, specifying in detail the cause for termination.

7. **INDEMNIFICATION FOR DAMAGES, TAXES AND CONTRIBUTIONS.** To the fullest extent permitted by applicable law, CONTRACTOR shall exonerate, indemnify, defend, and hold harmless COUNTY (which for the purpose of paragraphs 7 and 8 shall include, without limitation, its officers, agents, employees and volunteers) from and against:



A. Any and all claims, demands, losses, damages, defense costs, or liability of any kind or nature which COUNTY may sustain or incur or which may be imposed upon it which arise out of, pertain to, or relate to CONTRACTOR’S negligence, recklessness, or willful misconduct under the terms of this Agreement. Such indemnification includes any damage to the person(s), or property(ies) of CONTRACTOR and third persons.

B. Any and all Federal, State, and Local taxes, charges, fees, or contributions required to be paid with respect to CONTRACTOR and CONTRACTOR’S officers, employees and agents engaged in the performance of this Contract (including, without limitation, unemployment insurance, social security and payroll tax withholding).

**8. INSURANCE.** CONTRACTOR, at its sole cost and expense, for the full term of this Contract (and any extensions thereof), shall obtain and maintain, at minimum, compliance with all of the following insurance coverage(s) and requirements. Such insurance coverage shall be primary coverage as respects COUNTY and any insurance or self-insurance maintained by COUNTY shall be considered in excess of CONTRACTOR’S insurance coverage and shall not contribute to it. If CONTRACTOR normally carries insurance in an amount greater than the minimum amount required by the COUNTY for this Contract, that greater amount shall become the minimum required amount of insurance for purposes of this Contract. Therefore, CONTRACTOR hereby acknowledges and agrees that any and all insurances carried by it shall be deemed liability coverage for any and all actions it performs in connection with this Contract. Insurance is to be obtained from insurers reasonably acceptable to the COUNTY.

If CONTRACTOR utilizes one or more subcontractors in the performance of this Contract, CONTRACTOR shall obtain and maintain Contractor’s Protective Liability insurance as to each subcontractor or otherwise provide evidence of insurance coverage from each subcontractor equivalent to that required of CONTRACTOR in this Contract, unless CONTRACTOR and COUNTY both initial here \_\_\_ / \_\_\_.

**A. Types of Insurance and Minimum Limits**

(1) Workers’ Compensation Insurance in the minimum statutorily required coverage amounts. This insurance coverage shall be required unless the CONTRACTOR has no employees and certifies to this fact by initialing here \_\_\_\_\_.

(2) Automobile Liability Insurance for each of CONTRACTOR’S vehicles used in the performance of this Contract, including owned, non-owned (e.g. owned by CONTRACTOR’S employees), leased or hired vehicles, in the minimum amount of \$500,000 combined single limit per occurrence for bodily injury and property damage. This insurance coverage is required unless the CONTRACTOR does not drive a vehicle in conjunction with any part of the performance of this Contract and CONTRACTOR and COUNTY both certify to this fact by initialing here \_\_\_ / \_\_\_.

(3) Comprehensive or Commercial General Liability Insurance coverage at least as broad as the most recent ISO form CG 00 01, with a minimum limit of \$1,000,000 per occurrence and \$2,000,000 aggregate, including coverage for: (a) products and completed operations; (b) bodily and personal injury, (c) broad form property damage, (d) contractual liability, and (e) cross-liability.

(4) Professional Liability Insurance in the minimum amount of \$\_\_\_\_\_ combined single limit, if, and only if, this Subparagraph is initialed by CONTRACTOR and COUNTY \_\_\_ / \_\_\_.

///

**B. Other Insurance Provisions**

(1) If any insurance coverage required in this Contract is provided on a “Claims Made” rather than “Occurrence” form, CONTRACTOR agrees that the retroactive date thereof shall be no later than the date first written above (in the first paragraph on page 1), and that it shall maintain the required coverage for a period of three (3) years after the expiration of this Contract (hereinafter “post Contract coverage”) and any extensions thereof. CONTRACTOR may maintain the required post Contract coverage by renewal or purchase of prior acts or tail coverage. This provision is contingent upon post Contract coverage being both available and reasonably affordable in relation to the coverage provided during the term of this Contract. For purposes of interpreting this requirement, a cost not exceeding 100% of the last annual policy premium during the term of this Contract in order to purchase prior acts or tail coverage for post Contract coverage shall be deemed to be reasonable.

(2) All policies of Comprehensive or Commercial General Liability Insurance shall be endorsed to cover the County of Santa Cruz, its officials, employees, agents and volunteers as additional insureds with respect to liability arising out of the work or operations and activities performed by or on behalf of CONTRACTOR, including materials, parts or equipment furnished in connection with such work or operations. Endorsements shall be at least as broad as ISO Form CG 20 10 11 85, or both CG 20 10 10 01 and CG 20 37 10 01, covering both ongoing operations and products and completed operations.

Should CONTRACTOR fail to obtain such an endorsement to any policy required hereunder, CONTRACTOR shall be responsible to provide at least thirty (30) days’ notice (10 days for nonpayment of premium) of cancellation of such policy to the COUNTY as a material term of this Contract.

(3) All required insurance policies shall be endorsed to contain the following clause: “This insurance shall not be canceled until after thirty (30) days’ (10 days for nonpayment of premium) prior written notice has been given to:

**Santa Cruz County**  
**[Enter Department Name]**  
**Attn: [Enter Department Contact]**  
**701 Ocean Street, [Enter Room number]**  
**Santa Cruz, CA 95060**

Should CONTRACTOR fail to obtain such an endorsement to any policy required hereunder, CONTRACTOR shall be responsible to provide at least thirty (30) days’ notice (10 days for nonpayment of premium) of cancellation of such policy to the COUNTY as a material term of this Contract.

(4) CONTRACTOR agrees to provide its insurance broker(s) with a full copy of these insurance provisions and provide COUNTY on or before the effective date of this Contract with Certificates of Insurance and endorsements for all required coverages. However, failure to obtain the required documents prior to the work beginning shall not waive the CONTRACTOR’s obligation to provide them. All Certificates of Insurance and endorsements shall be delivered or sent to:

**Santa Cruz County**  
**[Enter Department Name]**  
**Attn: [Enter Department Contact]**  
**701 Ocean Street, [Enter Room number]**  
**Santa Cruz, CA 95060**

(5) CONTRACTOR hereby grants to COUNTY a waiver of any right of subrogation which any insurer of said CONTRACTOR may acquire against the COUNTY by virtue of the payment of any loss under such insurance. CONTRACTOR agrees to obtain any endorsement that may be necessary to affect this waiver of subrogation, but this provision applies regardless of whether or not the COUNTY has received a waiver of subrogation endorsement from the insurer.

**9. EQUAL EMPLOYMENT OPPORTUNITY.** During and in relation to the performance of this Contract, CONTRACTOR agrees as follows:

A. The CONTRACTOR shall not discriminate against any employee or applicant for employment because of race, color, creed, religion, national origin, ancestry, physical or mental disability, medical condition (including cancer-related and genetic characteristics), marital status, sexual orientation, age (over 18), veteran status, gender, pregnancy, or any other non-merit factor unrelated to job duties. Such action shall include, but not be limited to, the following: recruitment, advertising, layoff or termination, rates of pay or other forms of compensation, selection for training (including apprenticeship), employment, upgrading, demotion, or transfer. The CONTRACTOR agrees to post in conspicuous places, available to employees and applicants for employment, notice setting forth the provisions of this non-discrimination clause.

B. If this Contract provides compensation in excess of \$50,000 to CONTRACTOR and if CONTRACTOR employs fifteen (15) or more employees, the following requirements shall apply:

(1) The CONTRACTOR shall, in all solicitations or advertisements for employees placed by or on behalf of the CONTRACTOR, state that all qualified applicants will receive consideration for employment without regard to race, color, creed, religion, national origin, ancestry, physical or mental disability, medical condition (including cancer-related and genetic characteristics), marital status, sexual orientation, age (over 18), veteran status, gender, pregnancy, or any other non-merit factor unrelated to job duties. Such action shall include, but not be limited to, the following: recruitment; advertising, layoff or termination, rates of pay or other forms of compensation, selection for training (including apprenticeship), employment, upgrading, demotion, or transfer. In addition, the CONTRACTOR shall make a good faith effort to consider Minority/Women/Disabled Owned Business Enterprises in CONTRACTOR'S solicitation of goods and services. Definitions for Minority/Women/Disabled Owned Business Enterprises are available from the COUNTY General Services Purchasing Division.

(2) In the event of the CONTRACTOR'S non-compliance with the non-discrimination clauses of this Contract or with any of the said rules, regulations, or orders said CONTRACTOR may be declared ineligible for further contracts with the COUNTY.

(3) The CONTRACTOR shall cause the foregoing provisions of subparagraphs 9B(1) and 9B(2) to be inserted in all subcontracts for any work covered under this Contract by a subcontractor compensated more than \$50,000 and employing more than fifteen (15) employees, provided that the foregoing provisions shall not apply to contracts or subcontracts for standard commercial supplies or raw materials.

**10. INDEPENDENT CONTRACTOR STATUS.** CONTRACTOR and COUNTY have reviewed and considered the principal test and secondary factors below and agree that CONTRACTOR is an independent contractor and not an employee of COUNTY. CONTRACTOR is responsible for all insurance (workers' compensation, unemployment, etc.) and all payroll related taxes. CONTRACTOR is not entitled to any employee benefits. COUNTY agrees that CONTRACTOR shall have the right to control the manner and means of accomplishing the result contracted for herein.

**PRINCIPAL TEST:** The CONTRACTOR rather than COUNTY has the right to control the manner and means of accomplishing the result contracted for.

**SECONDARY FACTORS:** (a) The extent of control which, by agreement, COUNTY may exercise over the details of the work is slight rather than substantial; (b) CONTRACTOR is engaged in a distinct occupation or business; (c) In the locality, the work to be done by CONTRACTOR is usually done by a specialist without supervision, rather than under the direction of an employer; (d) The skill required in the particular occupation is substantial rather than slight; (e) The CONTRACTOR rather than the COUNTY supplies the instrumentalities, tools and work place; (f) The length of time for which CONTRACTOR is engaged is of limited duration rather than indefinite; (g) The method of payment of CONTRACTOR is by the job rather than by the time; (h) The work is part of a special or permissive activity, program, or project, rather than part of the regular business of COUNTY; (i) CONTRACTOR and COUNTY believe they are creating an independent contractor relationship rather than an employer-employee relationship; and (j) The COUNTY conducts public business.

It is recognized that it is not necessary that all secondary factors support creation of an independent contractor relationship, but rather that overall there are significant secondary factors that indicate that CONTRACTOR is an independent contractor.

By their signatures on this Contract, each of the undersigned certifies that it is his or her considered judgment that the CONTRACTOR engaged under this Contract is in fact an independent contractor.

**11. NONASSIGNMENT.** CONTRACTOR shall not assign the Contract without the prior written consent of the COUNTY.

**12. ACKNOWLEDGMENT.** CONTRACTOR shall acknowledge in all reports and literature that the Santa Cruz County Board of Supervisors has provided funding to the CONTRACTOR.

**13. RETENTION AND AUDIT OF RECORDS.** CONTRACTOR shall retain records pertinent to this Contract for a period of not less than five (5) years after final payment under this Contract or until a final audit report is accepted by COUNTY, whichever occurs first. CONTRACTOR hereby agrees to be subject to the examination and audit by the Santa Cruz County Auditor-Controller-Treasurer-Tax Collector, the Auditor General of the State of California, or the designee of either for a period of five (5) years after final payment under this Contract.

**14. PRESENTATION OF CLAIMS.** Presentation and processing of any or all claims arising out of or related to this Contract shall be made in accordance with the provisions contained in Chapter 1.05 of the Santa Cruz County Code, which by this reference is incorporated herein.

15. **ATTACHMENTS.** Should a conflict arise between the language in the body of this Contract and any attachment to this Contract, the language in the body of this Contract controls. This Contract includes the following attachments:

(enter attachments here)

16. **LIVING WAGE.** This Contract is covered under Living Wage provisions if this section is initialed by COUNTY\_\_\_\_\_.

If Item # 16 above is initialed by COUNTY, then this Contract is subject to the provisions of Santa Cruz County Code Chapter 2.122, which requires payment of a living wage to covered employees. Non-compliance during the term of the Contract with these Living Wage Provisions will be considered a material breach, and may result in termination of the Contract and/or pursuit of other legal or administrative remedies.

CONTRACTOR agrees to comply with Santa Cruz County Code section 2.122.140, if applicable.

17. **NON-BINDING UNTIL APPROVED.** Regardless of whether this Contract has been signed by all parties, if the total compensation identified in Paragraph 2 of this Contract is greater than \$35,000, this Contract is not binding on any party until the Contract has been approved by the Santa Cruz County Board of Supervisors.

18. **MISCELLANEOUS.** This written Contract, along with any attachments, is the full and complete integration of the parties' agreement forming the basis for this Contract. The parties agree that this written Contract supersedes any previous written or oral agreements between the parties, and any modifications to this Contract must be made in a written document signed by all parties. The unenforceability, invalidity or illegality of any provision(s) of this Contract shall not render the other provisions unenforceable, invalid or illegal. Waiver by any party of any portion of this Contract shall not constitute a waiver of any other portion thereof. Any arbitration, mediation, or litigation arising out of this Contract shall occur only in the County of Santa Cruz, notwithstanding the fact that one of the contracting parties may reside outside of the County of Santa Cruz. This Contract shall be governed by, and interpreted in accordance with, California law.

///

///

///

///

SIGNATURE PAGE

Contract No. \_\_\_\_\_

**INDEPENDENT CONTRACTOR AGREEMENT**  
**(DESIGN PROFESSIONALS)**

IN WITNESS WHEREOF, the parties hereto have set their hands the day and year first above written.

2. **(ENTER CONTRACTOR NAME)**

4. **COUNTY OF SANTA CRUZ**

By: \_\_\_\_\_  
SIGNED

By: \_\_\_\_\_  
SIGNED

\_\_\_\_\_  
PRINTED

\_\_\_\_\_  
PRINTED

Company Name: \_\_\_\_\_

Address: \_\_\_\_\_  
\_\_\_\_\_

Telephone: \_\_\_\_\_

Fax: \_\_\_\_\_

Email: \_\_\_\_\_

3. **APPROVED AS TO INSURANCE:**

1. **APPROVED AS TO FORM:**

\_\_\_\_\_  
Risk Management

\_\_\_\_\_  
Office of the County Counsel

DISTRIBUTION:

- [Enter Initiating Department Name]
- Auditor-Controller-Treasurer-Tax Collector
- Risk Management
- Contractor

Attachment: 2017-SCCDPW Library Renovation RFQ (Approval of RFQ for the Santa Cruz County Library Renovation Project)

## Attachment A6

### PROTESTS AND APPEALS PROCEDURES

#### 1. **Protests to the Director of Public Works**

Any actual or prospective bidder, offerer or contractor who is allegedly aggrieved in connection with the solicitation or award of a contract, other than a bid protest, may protest to the Director of Public Works. The protest shall be submitted in writing to the Director of Public Works (Purchasing Agent) within five (5) working days after notification of the recommendation of award.

#### 2. **Decision of the Director of Public Works**

The Director of Public Works shall issue a written decision within ten (10) working days after receipt of the protest. The decision shall:

- (a) State the reason for the action taken;
- (b) Inform the protestant that a request for further administrative appeal of an adverse decision must be submitted in writing to the Clerk of the Board of Supervisors within seven (7) working days after receipt of the decision made by the Director of Public Works. However, if the underlying protested award is not subject to approval by the Board of Supervisors (contracts for services for up to \$15,000), then the Director of Public Works' decision shall be final.

The Director of Public Works shall discuss with County Counsel all protests prior to issuing a written decision.

#### 3. **Protests and Appeals to the Board of Supervisors**

(a) If permitted under Section 2(b) above, the decision of the Director of Public Works may be appealed to the Board of Supervisors.

(b) Any actual or prospective bidder, offerer or contractor who is allegedly aggrieved may protest a bid to the Board of Supervisors.

#### 4. **Time Limits for Filing Protests and Appeals to the Board of Supervisors**

Protests and appeals to the Board of Supervisors must be filed no later than ten days after the date of the decision being protested or appealed. The County shall be considered an interested party. When the appeal period ends on a day when the County offices are not open to the public for business, the time limits shall be extended to the next full working day.

#### 5. **Content of Protest and Appeal; Stay of Award**

Any appeal or protest shall be filed in writing with the Clerk of the Board of Supervisors and shall state, as appropriate, any of the following:

A determination or interpretation is not in accord with the purpose of these procedures or County Code;

There was an error or abuse of discretion;

The record includes inaccurate information; or

A decision is not supported by the record.

In the event of a timely appeal before the Board of Supervisors under this Section, the County shall not proceed further with the solicitation or with the award of the contract until the appeal is resolved, unless the County Administrative Officer, in

consultation with County Counsel, the Director of Public Works, and the using department, makes a written determination that the award of the contract without delay is necessary to protect a substantial interest of the County.

**6. Protest and Appeal Procedure**

- (a) **Hearing Date.** A hearing before the Board shall be scheduled within thirty days of the County's receipt of a protest or appeal unless the protestor and County both consent to a later date.
- (b) **Notice and Public Hearing.** The hearing shall be a public hearing. Notice shall be mailed or delivered to the protestor not later than ten days before the scheduled hearing date.
- (c) **Hearing.** At the hearing, the Board shall review the record of the process or decision, and hear oral explanations from the protestor and any other interested party.
- (d) **Decision and Notice.** After the hearing, the Board shall affirm, modify or revise the original decision. When a decision is modified or reversed, the Board shall state the specific reasons for modification or reversal. The Clerk of the Board of Supervisors shall mail notice of the Board decision. Such notice shall be mailed to the protestor within five working days after the date of the decision, and to any other party requesting such notice.
- (e) **A decision by the Board shall become final on the date the decision is announced to the public.**



## Attachment A7

### RESERVATIONS

County and the Santa Cruz County Department of Public Works reserves the right at its sole discretion to do any of the following at any time:

- A. Reject any or all responses or proposals, without indicating any reasons for such rejection;
- B. Waive or correct any minor or inadvertent defect, irregularity or technical error in any response or proposal, the RFQ, any related procedure, or any subsequent negotiation process;
- C. Terminate this RFQ and issue a new Request for Proposals anytime thereafter;
- D. Procure any materials or services specified in the RFQ by other means;
- E. Extend any or all deadlines specified in the RFQ, including deadlines for accepting RFQ submittals, by issuance of an Addendum at any time prior to the deadline to submit RFP responses;
- F. Disqualify, at the sole discretion of the County, any Respondent on the basis of any real or perceived conflict of interest or evidence of collusion that is disclosed by the RFQ response or by other data or means available to the County;
- G. Reject the response of any Respondent that is in breach of or in default under any other agreement with the County; and
- H. Reject any Respondent deemed by the County to be non-responsive, unreliable, unqualified, or who is believed to have submitted false information.